



Display and control unit

Multitronik

Installation and Operation Instructions

Original instructions





Bühler Technologies GmbH, Harkortstr. 29, D-40880 Ratingen
Tel. +49 (0) 21 02 / 49 89-0, Fax: +49 (0) 21 02 / 49 89-20
Internet: www.buehler-technologies.com
E-Mail: fluidcontrol@buehler-technologies.com

Read this instruction carefully prior to installation and/or use. Pay attention particularly to all advises and safety instructions to prevent injuries. Bühler Technologies can not be held responsible for misusing the product or unreliable function due to unauthorised modifications.

All rights reserved. Bühler Technologies GmbH 2023

Document information

Document No.....BE140014
Version..... 12/2019

Contents

1	Introduction	3
1.1	Intended Use	3
1.2	Design types	3
1.3	Model key	3
1.4	Contents	3
2	Safety instructions	4
2.1	Important advice	4
2.2	General hazard warnings	4
3	Transport and storage	6
4	Setup and connection	7
4.1	Installation	7
4.2	Electrical connections	7
5	Operation and control	8
5.1	Start-up procedure	8
5.2	LED statuses	8
5.3	General key functions	9
5.4	Keylock enabled	9
5.5	Menu overview	10
5.6	Changing basic settings	11
5.6.1	Disabling normal error handling	11
5.6.2	Define switching outputs	11
5.6.3	Set unit	12
5.6.4	Set display refresh rate	12
5.6.5	Enable/disable keylock	13
5.6.6	Assigning the upper limit of the sensor measuring range	13
5.6.7	Sensor measuring range lower limit assignment	13
5.6.8	Restore factory settings (Reset)	14
5.7	Switching outputs	15
5.7.1	Switching output x: Definition of the switching characteristic	16
5.7.2	Switching output x: Upper switching limit (switching point)	17
5.7.3	Switching output x: Lower switching limit (switch-back point)	17
5.7.4	Switching output x: Switch-on delay	18
5.7.5	Switching output x: Switch-back delay	18
5.7.6	Switching output x: Testing the switching output	18
5.7.7	Change status LED display function	19
5.8	Analogue outputs	20
5.8.1	Analogue output x: Assigning the upper limit	20
5.8.2	Analogue output x: Lower limit assignment	20
5.8.3	Analogue output x: Signal type assignment	20
5.8.4	Analogue output x: Testing the analogue output	21
5.9	Diagnostic options	21
5.9.1	View logbook	21
5.9.2	Maximum and minimum measurement	22
5.9.3	Define switching output to log	22
5.9.4	Delay for storing the Min/Max measurement	23
6	Cleaning and Maintenance	24
7	Service and repair	25
7.1	Troubleshooting	25
7.2	Spare parts and accessories	26
8	Disposal	27
9	Appendices	28
9.1	Multitronik Technical Data	28
9.2	Multitronik standard pin assignment	29
9.3	Current settings	30

9.4	Display ranges	30
9.5	Display resolution	31
9.6	Menu Sequence Overview	32
10	Attached documents	33

1 Introduction

1.1 Intended Use

The Multitronik display and control unit allows for connecting various liquid level, temperature or pressure monitoring sensors with 4-20 mA output.

Please note the technical data in the appendix for the specific intended use, existing material combinations, as well as pressure and temperature limits.

WARNING



All device models are solely intended for industrial applications. They are **not safety components**. The devices must not be used if failure or malfunction thereof jeopardises the safety and health of persons. Use in explosive areas is **prohibited**.

1.2 Design types

The Multitronik is equipped with different switching and analogue outputs based on the configuration. The outputs are freely programmable.

Please refer to the type plate for your equipment configuration. In addition to the job number, this also contains the item number and type designation

1.3 Model key

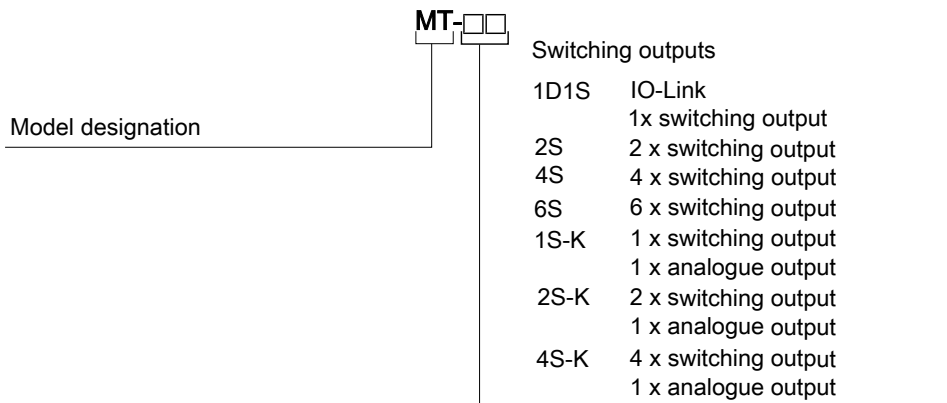

1.4 Contents

- Multitronik
- Product documentation
- Connection/mounting accessories (optional)

2 Safety instructions

2.1 Important advice

Operation of the device is only valid if:

- the product is used under the conditions described in the installation- and operation instruction, the intended application according to the type plate and the intended use. In case of unauthorized modifications done by the user Bühler Technologies GmbH can not be held responsible for any damage,
- when complying with the specifications and markings on the nameplates.
- the performance limits given in the datasheets and in the installation- and operation instruction are obeyed,
- monitoring devices and safety devices are installed properly,
- service and repair is carried out by Bühler Technologies GmbH,
- only original spare parts are used.

This manual is part of the equipment. The manufacturer keeps the right to modify specifications without advanced notice. Keep this manual for later use.

Signal words for warnings

DANGER	Signal word for an imminent danger with high risk, resulting in severe injuries or death if not avoided.
WARNING	Signal word for a hazardous situation with medium risk, possibly resulting in severe injuries or death if not avoided.
CAUTION	Signal word for a hazardous situation with low risk, resulting in damaged to the device or the property or minor or medium injuries if not avoided.
NOTICE	Signal word for important information to the product.

Warning signs

These instructions use the following warning signs:



Warns of a general hazard



General information



Voltage warning



Unplug from mains

2.2 General hazard warnings

The equipment must be installed by a professional familiar with the safety requirements and risks.

Be sure to observe the safety regulations and generally applicable rules of technology relevant for the installation site. Prevent malfunctions and avoid personal injuries and property damage.

The operator of the system must ensure:

- Safety notices and operating instructions are available and observed,
- The respective national accident prevention regulations are observed,
- The permissible data and operational conditions are maintained,
- Safety guards are used and mandatory maintenance is performed,
- Legal regulations are observed during disposal,
- compliance with national installation regulations.

Maintenance, Repair

Please note during maintenance and repairs:

- Repairs to the unit must be performed by Bühler authorised personnel.
- Only perform conversion-, maintenance or installation work described in these operating and installation instructions.
- Always use genuine spare parts.
- Do not install damaged or defective spare part. If necessary, visually inspect prior to installation to determine any obvious damage to the spare parts.

Always observe the applicable safety and operating regulations in the respective country of use when performing any type of maintenance.

The method for cleaning the devices must be adapted to the IP protection class of the devices. Do not use cleaners which could damage the device materials.

3 Transport and storage

Only transport the product inside the original packaging or a suitable alternative.

The equipment must be protected from moisture and heat when not in use. It must be stored in a covered, dry, dust-free room at room temperature.

4 Setup and connection

DANGER
Electric voltage

Risk of electric shock



- a) Always disconnect the unit from the mains before performing work.
- b) Secure the equipment from accidental restarting.
- c) The equipment may only be installed, maintained and put into operation by instructed, competent personnel.
- d) Always observe the applicable safety regulations for the operating site.



4.1 Installation

The Multitronik mounts to a 35 mm (1.4") top-hat rail. This allows it to easily be mounted in a central location without additional mounting aids or installed in control cabinets.

The sensors connect via M12-plug-in connectors and a standard cable and make a modern control unit when combined with the Multitronik.

DANGER
Electric voltage
Risk of electric shock

When connecting devices, please note the maximum voltages and currents (see technical data) and use the correct wire cross-sections and circuit breakers.

When selecting the connection lines, also note the maximum operating temperatures of the devices.

Installation in special areas of application:

If the device will be installed outdoors or in wet areas, the maximum operating voltage is max. 16 V DC effective or 35 V DC.



4.2 Electrical connections

A cable connects the sensor to a jack at the bottom of the device. This cable also supplies the input signal for the sensor.

Electricity is supplied via plug connectors. Please refer to the appendix for installation dimensions, nominal voltage and plug configuration.

The temperature switching outputs are PNP transistors (see illustration):

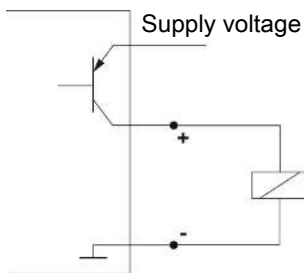

Note: When measuring the switching output with high-load measuring device inputs or when used as a frequency output, the load must be set to 10 kΩ between the output and earth (GND) to avoid faulty measurements.

5 Operation and control

NOTICE



The device must not be operated beyond its specifications.

5.1 Start-up procedure

The device will automatically switch on when connected to power. It will first briefly display the software version, at which time the device will also check the built-in components. The display will then switch to displaying measurements.

The following describes the function of the display and control unit:

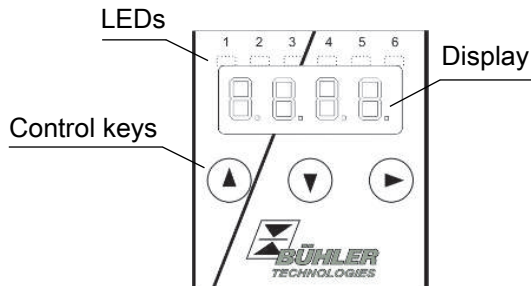



If an error message appears in the display during operation, please refer to the **Troubleshooting** table under chapter “Service and Repair”.

5.2 LED statuses

LEDs above the measurement display indicate the status of the switching outputs. The LEDs are permanently assigned to the switching outputs.

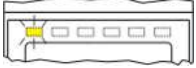
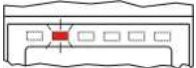
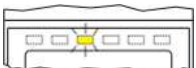
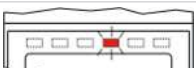
The following table shows the factory settings:

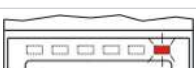
	LED 1 – yellow Status switching output 1
	LED 2 - red Status switching output 2 (if applicable)
	LED 3 – yellow Status switching output 3 (if applicable)
	LED 4 – red Status switching output 4 (if applicable)
	LED 5 – yellow Status switching output 5 (if applicable)
	LED 6 – red Status switching output 6 (if applicable)

The switching characteristics of the LED (on if switching contact closed or open) can be changed.

5.3 General key functions

The keys below the display are used for operation.

The menu controls are detailed in the following chapters.

Key	Mode	Function
▶	– Measurement display:	Toggles the display unit.
	– In the menu:	Move down one menu level. Move up one menu level.
	– At the end of the menu:	 The display indicates the end of the menu.
	– Following input/selection:	Confirm and save a numerical value entered or a function selection. The display will flash if a parameter has been changed.
▲	– Measurement display:	Displays the configuration.
	– In the menu:	Scroll up menu item, numerical value or function selection. Holding the key will continuously scroll.
▼	– Measurement display:	Go to main menu.
	– In the menu:	Scroll down menu item, numerical value or function selection. Holding the key will continuously scroll.
▼ + ▶	– In the menu:	Exit the main / sub / drop-down menu and return to displaying the measurement without saving changes to the parameters.
▲ + ▶	– In the menu:	Move to the next higher menu level.
60 s no action	– In the menu:	Exit the main / sub/ drop-down menu.

To select a menu item and to enter values:

- Open the main menu with the ▼ key.
- Select the submenu with the ▼ and ▲ keys and open the submenu with the ▶ key.
- If necessary, select the next submenu with the ▼ and ▲ keys and open with the ▶ key.
- Select the desired menu item with the ▼ and ▲ keys and open the list of values with the ▶ key.
- Set the value with the ▼ and ▲ keys and confirm with the ▶ key. The new settings will be saved and the device will return to the submenu.
- Select the menu item EXIT to exit the submenu and confirm with the ▶ key. The device will return to the next menu level up or to the measurement display.

5.4 Keylock enabled

With the keylock enabled, selecting the menu with the ▼ key will display  in place of the main menu. The active digit will be indicated by a dot.

- Use the ▲ and ▼ keys to enter the code and confirm with the ▶ key. The active digit will move one place to the right. After entering the 3rd digit the main menu will open.

If the wrong code is entered, the device will return to the measurement display. If you forgot the password you can always enter master code 287 to access the menu.

You can cancel the keylock under *Loc* in submenu **Basic Settings Advanced Options** *bEF* and enter 000 to reset the code.

5.5 Menu overview

The menu structure is based on the VDMA standard sheet 24574-1. The menu structure is hierarchic. The top menu level contains the main menu items, e.g. *Multitronik*, *bEF*, *d.R*, *E*. Each main menu has additional submenu items.

The menu items may vary depending on the device configuration. Not all menu items described below will necessarily apply to your device. Press the ▲ key in display mode to open the configuration. A 4-digit code will appear, e.g.

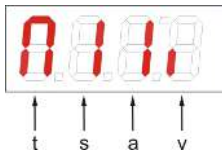

With the 4 digits tsav meaning:

- t: Model
- s: Number of switching outputs
- a: Number of analogue outputs
- v: Device installation type

M = Multitronik

1, 2, 4 or 6

0 for 1

i = standard installation (top-hat rail)

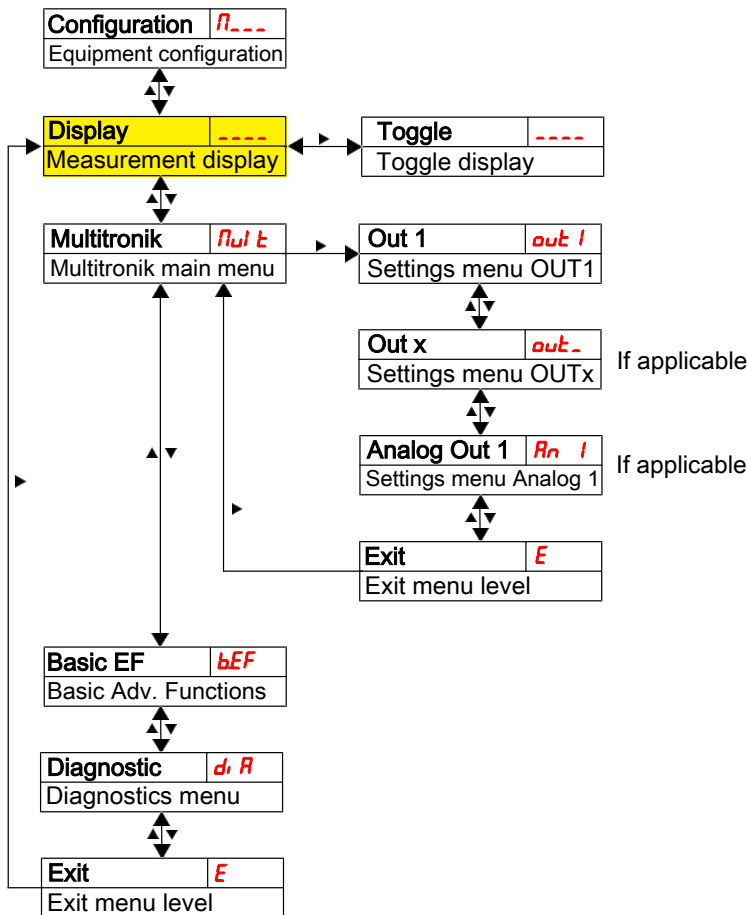

The individual menu items will not be shown if the option does not apply. Example: With a=0 the menu items for configuring the analogue output does not apply. You can then skip the description for this item.

The **Multitronik** (*Multitronik*) main menu is used to configure the settings for the switching outputs or the Analogue outputs (if applicable).

The basic device settings can be changed. General settings can be configured under **Basic Settings Advanced Functions** (*bEF*). These settings should be configured first, as they affect the displays and settings for the individual menus. These settings are e.g. the units used and allocating switching outputs. The allocation of the analogue outputs cannot be changed.

The **Diagnostic** (*d.R*) menu further contains diagnostics options.

You will find the detailed illustration of the entire menu structure at the end of these instructions.

5.6 Changing basic settings

The general basic settings can be changed under menu **Basic Settings Extended Functions (bEF)**. These settings will affect the measurement display and the configuration options in the various main menus. Here you can also change the switching output assignment.

- Press the **▼** key to open the main menu.
- Select menu item **(EF)** using the **▼** and **▲** keys and open the menu with the **►** key.

NOTICE

Disabling normal error handling



Disabling normal error handling and analysis could potentially cause dangerous operating states, dangers to the user or machines. Before using this option, review the hazard potential within the process. With this setting, Bühler Technologies GmbH assumes no liability for injuries to health or material damage caused by this setting.

5.6.1 Disabling normal error handling

Here you can enable/disable normal error handling and analysis.

The function Disable error handling (**Errh**) is used to disable normal error handling and analysis. This may pose dangers to the user or machine.

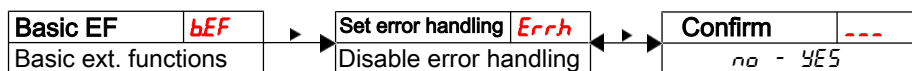

The options are:



Disables normal error handling.

Enables normal error handling (default)

Important note: When exceeding the measuring range or if sensor errors occur, the measurement will be frozen and all six LEDs in the status bar will blink. When the measurement returns to the permissible range the LEDs will stop blinking and the display will refresh again as usual.

5.6.2 Define switching outputs

Here you can define the switching outputs.

Use the “Define switching outputs” function to define the switching outputs (**rou1** and **rou2**). The switching outputs can be configured as **Err** or **Mult**.

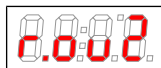
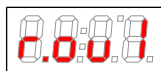
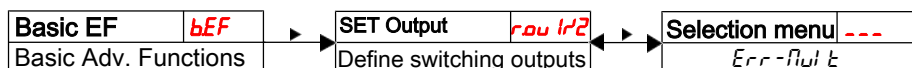

The options are:

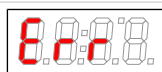

Err



Mult

Options:

[Err, Mult]

Note:

- Switching outputs 1 and 2 can alternatively be wired as error indicators. In this case the output will be connected as a NC contact which opens when exceeding the range or if an error occurs. The LED assigned to this output will generally not be activated, as all 6 LEDs in the status bar will blink if an error occurs.
- When defining a switching output as an error indicator it will no longer be an option for normal switching output settings.

5.6.3 Set unit

Used to set the unit symbol:

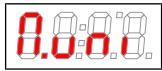

The options are:

Temperature			Pressure		
°C	°F	mbar	bar	MPa	psi
Liquid Level					none
Percent	cm	inch	Litre	Gallons	
					none

Note:

- When selecting *non* “no unit”, the display will scale measurements to a four-digit output. *non 1* and *non 2* each have one or two fixed decimal places.
- Measurements are not automatically converted. After switching the unit (if necessary), the measuring range should be scaled.

5.6.4 Set display refresh rate

The refresh rate of the display can be changed based on the application. The display can also be completely disabled. The LEDs will remain functional.

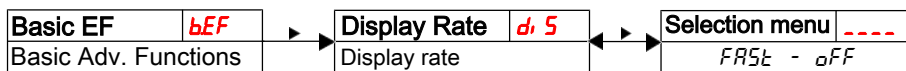

The options are:

fast	medium	slow	Display off

Note:

- Error messages will still appear, even with the display off.

5.6.5 Enable/disable keylock

The keylock can be enabled to prevent unauthorised changes to the device settings.

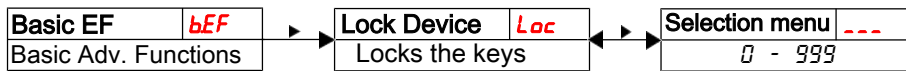

The keylock will be enabled after entering at least one digit > 0. A dot indicates the active digit during this input.



Setting range:
000 to 999

- Use the ▶ key to open the list of values:
- Enter the digit using the ▼ and ▲ keys (0 to 9) and press the ▶ key to confirm. The active digit will move one place to the right.
- Lastly, press the ▶ key to confirm the code. The device will now return to the submenu.

Note:

- To disable the keylock enter: 000

5.6.6 Assigning the upper limit of the sensor measuring range

This determines the display value (upper limit for the measuring range). This value appears when the input signal is 20 mA:

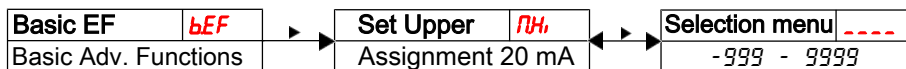

Setting range:
-999...9999

Assigning the maximum display value (upper limit of the measuring range):

Note:

- The measuring range is factory preset to 0-100 %.
- When connecting a different sensor, the measuring range may need to be changed accordingly. To prevent malfunctions, the settings for the level outputs should be reviewed or adjusted after making a change.
- The sensible setting range is based on the connected sensor and the unit selected, e.g.:
Temperature: 0° ... 100 °C (32 °F ... 212 °F)
Pressure: 0 bar (0 psi) ... max. pressure range for the sensor

5.6.7 Sensor measuring range lower limit assignment

This determines the display value (lower limit of the measuring range). This value appears when the input signal is 4 mA:

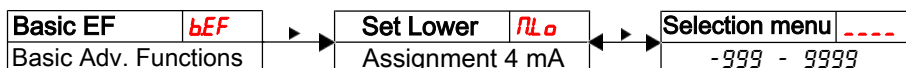

Setting range:
-999...9999

Assigning the smallest display value (lower limit of the measuring range):

Note:

- The measuring range is factory preset to 0-100 %.
- When connecting a different sensor, the measuring range may need to be changed accordingly. To prevent malfunctions, the settings for the level outputs should be reviewed or adjusted after making a change.
- The sensible setting range is based on the connected sensor and the unit selected, e.g.:
Temperature: 0° ... 100 °C (32 °F ... 212 °F)
Pressure: 0 bar (0 psi)... max. pressure range for the sensor

5.6.8 Restore factory settings (Reset)

Use the Reset function (*rES*) to restore the factory settings. All changes will be lost. Since this will also reset the limits, you must check the settings for the individual switching outputs.

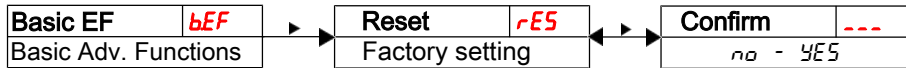

The options are:



Original status:
No,
keep current settings



Original status:
Yes,
reset settings to the factory defaults.

The factory settings are:

Definitions:

- SP x / rPX* Switching point / switch-back point x
- dS x / drX* Switch-on delay / switch-back delay for switching output x
- RxHi / RxLo* Maximum and minimum measurement for output
- Rou X* Analogue output signal type
- ou X* Switching characteristic for switching output x
- fluni* Unit
- flHi / flLo* Maximum / minimum liquid level
- di S* Display refresh rate
- Lac* Keylock
- Suou* Switching output logged
- dnnn* Delay for recording the minimum / maximum measurement

Note: For customer-specific specifications the factory preset may vary from those listed here.

Basic settings:

Basic Settings

<i>fluni</i>	- 1 -
<i>flHi</i>	100
<i>flLo</i>	0
<i>di S</i>	FRSt
<i>Lac</i>	000

Version with 1 switching output:

Switching outputs

<i>SP 1 / rP 1</i>	50 / 45
<i>dS 1 / dr 1 / ou 1</i>	0 / 0 / Hno

Version with 2 switching outputs:

Switching outputs

<i>SP 1 / rP 1</i>	50 / 45
<i>dS 1 / dr 1 / ou 1</i>	0 / 0 / Hno
<i>SP 2 / rP 2</i>	60 / 55
<i>dS 2 / dr 2 / ou 2</i>	0 / 0 / Hno

Version with 4 switching outputs:

Switching outputs	
SP1 / rP1	50 / 45
dS1 / dr1 / ou1	0 / 0 / Hno
SP2 / rP2	60 / 55
dS2 / dr2 / ou2	0 / 0 / Hno
SP3 / rP3	70 / 65
dS3 / dr3 / ou3	0 / 0 / Hno
SP4 / rP4	80 / 75
dS4 / dr4 / ou4	0 / 0 / Hno

Version with 6 switching outputs:

Switching outputs	
SP1 / rP1	50 / 45
dS1 / dr1 / ou1	0 / 0 / Hno
SP2 / rP2	60 / 55
dS2 / dr2 / ou2	0 / 0 / Hno
SP3 / rP3	70 / 65
dS3 / dr3 / ou3	0 / 0 / Hno
SP4 / rP4	80 / 75
dS4 / dr4 / ou4	0 / 0 / Hno
SP5 / rP5	80 / 75
dS5 / dr5 / ou5	0 / 0 / Hno
SP6 / rP6	80 / 75
dS6 / dr6 / ou6	0 / 0 / Hno

Version with analogue output:

Analogue output	
RHi / RLo / Rou1	0 / 100 / r1

Diagnostic settings:

Diagnostics	
Sdow	out1
nnn	00
dnnn	0

5.7 Switching outputs

All switching outputs are configured the same way. The switching output number is therefore represented by x. Open the switching output to be configured from the menu for the respective measured variable.

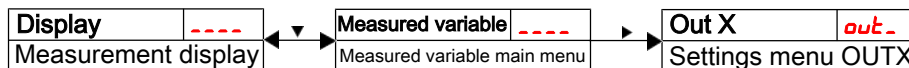

The switching output allocation and other basic settings related to all switching outputs can be configured in menu **Basic Settings Advanced Functions**.

Use submenu **Advanced Functions** to configure additional settings for each individual switching output which e.g. affect the switching characteristics of the output. The output can also be tested here.

5.7.1 Switching output x: Definition of the switching characteristic

The switching characteristic for the output can be configured under the following menu:

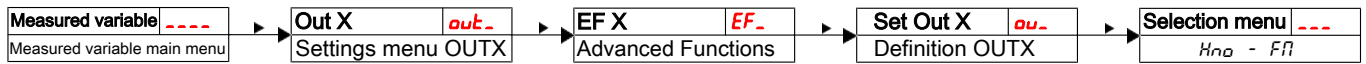

The options are:

Hysteresis Function

NO contact or NC contact function when the output signal is set when exceeding the configured switching point. The output signal will be deleted if the value is below the configured switch-back point.



Hysteresis function as the NO contact

Here, NO contact (H_{no}) means the PNP switching output is closed above switching point SP_x and opens below switching point rPx .

Here, NC contact (H_{nc}) means the PNP switching output is open above switching point SP_x and closes below switching point rPx .

Also see the explanation in the drawing below.

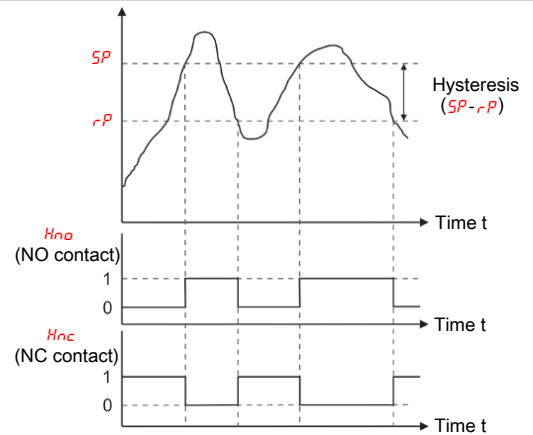

Window function

NO contact or NC contact function defining a signal window. When the measuring window is reached the output signal is set and deleted upon exiting.



Window function as NO contact

Here, NO contact (F_{no}) means the PNP switching output is closed if the value is within the window. Otherwise the switching output will be open.

Here, NC contact (F_{nc}) means the PNP switching output is open if the value is within the window. Otherwise the switching output will be closed.

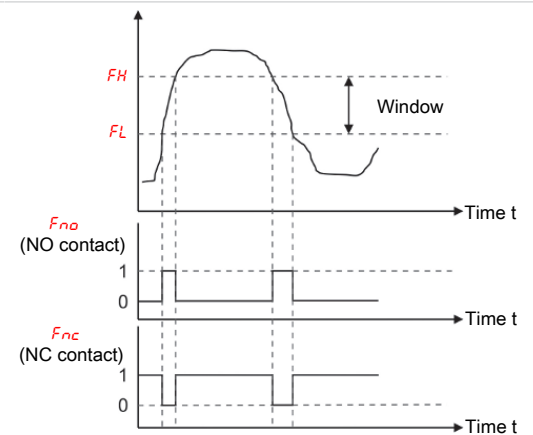

Frequency output

If the output is defined as a frequency output, a square wave signal with a frequency between 1 Hz and 100 Hz proportional to the measurement will be output.



Frequency output

Note: To increase the slew rate of the square wave signal, we recommend loading the switching output with an load of 10 k Ω .

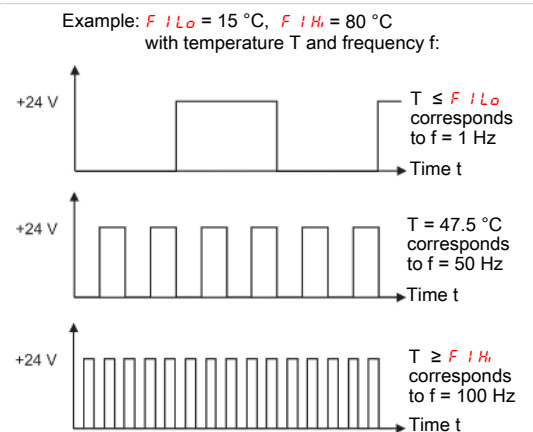

Note: The designation of the switching function may vary:

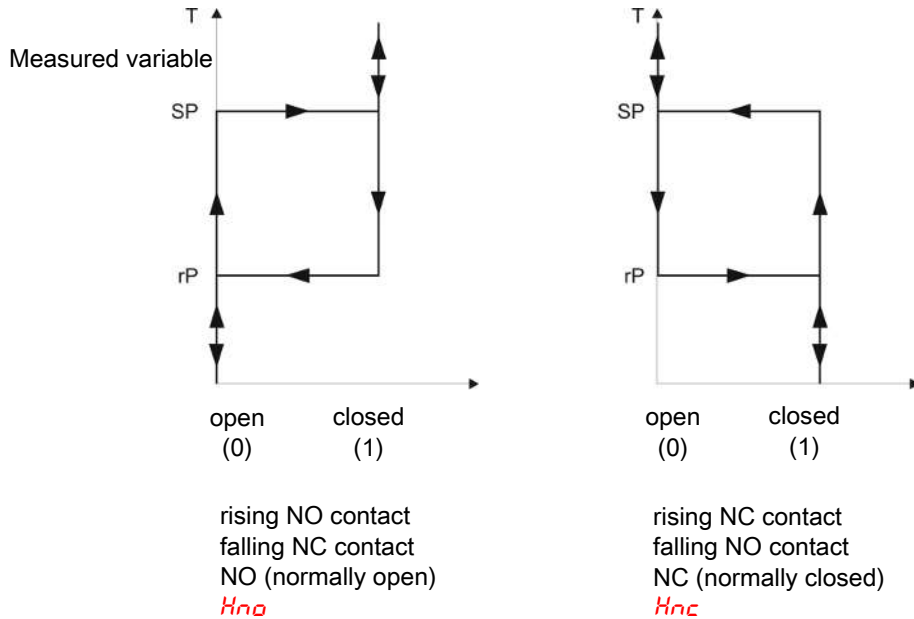

5.7.2 Switching output x: Upper switching limit (switching point)

The upper switching limit for switching output Out X can be defined with the following submenu:

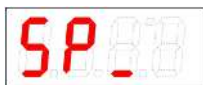
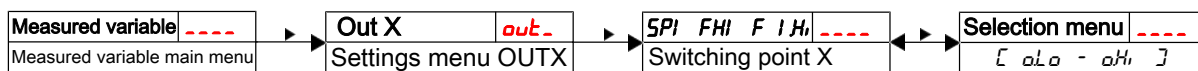

Switching point for OUT x

Setting range:
[rLo]...[rHi]

Note:

- The switching point must be set to within the range limits (see menu **Basic Settings Advanced Functions**).
- If switching output OUT 1 was assigned the function **Window**, will appear. The setting corresponds with the upper window limit.
- If switching output OUT 1 was assigned the function **Frequency output**, will appear. The setting corresponds to the frequency 100 Hz.

5.7.3 Switching output x: Lower switching limit (switch-back point)

The lower switching limit for switching output Out 1 can be defined in the following submenu:

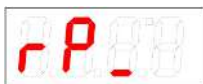
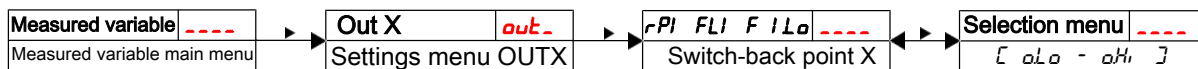

Switch-back point for OUT 1

Setting range:
[rLo]...[rHi]

Note:

- The switch-back point must be set to within the range limits.
- If switching output OUT 1 was assigned the function **Window**, will appear. The setting corresponds with the lower window limit.
- If switching output OUT 1 was assigned the function **Frequency output**, will appear. The setting corresponds to the frequency 1 Hz.

5.7.4 Switching output x: Switch-on delay

The menu **Advanced Functions EFx** is used to configure additional settings for switching output x. The submenu is at the second submenu level.

The switching and switch-back delay prevents the alarm being triggered too frequently in unstable conditions. The switching delay can be configured with the following menu:

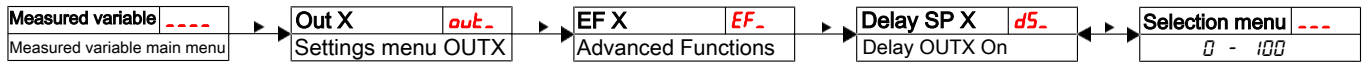

Time span in seconds during which the signal must be continuously present for the switching output to respond.

Note:

Setting range:
0...100 seconds

- If switching output OUT x was assigned the function **Window**, the setting corresponds to the switch-on delay which detects valid reaching of the measuring window.
- If switching output OUT x was assigned the function **Frequency output**, this value will have no affect.

5.7.5 Switching output x: Switch-back delay

The switch-back delay can be configured with the following menu:

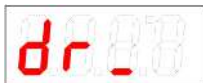
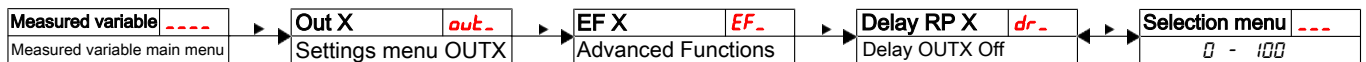

Switch-back signal delay for OUT x.

Time span in seconds during which the signal must be continuously present for the switching output to respond.

Note:

Setting range:
0...100 seconds

- If switching output OUT x was assigned the function **Window**, the setting corresponds to the switch-on delay which detects valid closing of the measuring window.
- If switching output OUT x was assigned the function **Frequency output**, this value will have no affect.

5.7.6 Switching output x: Testing the switching output

The switching output test can be started with the following menu:

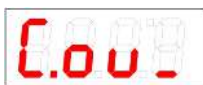
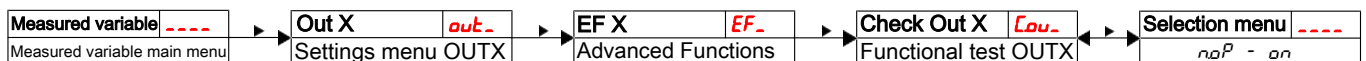

Switching output test option

Options when setting *ou 1* to *Hno / Hnc / Fno / Fnc*:



Normal switching output operation

Switching output permanently off disabled

Switching output permanently activated

Options when setting *ou 1* to *F? :*



Normal mode as frequency output

Output Frequency 1 Hz

Output Frequency 100 Hz



Note:

- **After completing the test, set the function to normal mode *noP*.**

5.7.7 Change status LED display function

The LEDs in the display indicate the switching status of the output. The following table shows how LEDs are allocated to the switching output:

Numbering LED	Switching output x	Assignment for 2 switching outputs	Assignment for 4 switching outputs	Assignment for 6 switching outputs
LED	1	LED 1 - yellow	LED 1 - yellow	LED 1 - yellow
1 2 3 4 5 6	2	LED 2 - red	LED 2 - red	LED 2 - red
	3		LED 3 - yellow	LED 3 - yellow
	4		LED 4 - red	LED 4 - red
	5			LED 5 - yellow
	6			LED 6 - red

In the factory setting the LED indicates the physical status of the PNP switching output (switching output closed – LED on).

The logical indicator function may need to be different from the physical signal on the switching output. You can therefore also reverse this indication with this menu (switching output open – LED on).





Example:

You have 2 switching outputs for the pressure, configured as:

- **Switching output 1:** Max. contact, rising NO contact. The LED lights up when the maximum value is exceeded and the pressure is above the desired range. So this LED lighting up indicates an "Error" status.
- **Switching output 2:** Min contact, rising NO contact. So in the factory setting, the LED lights up when exceeding the minimum pressure. So in this case the LED would light up if the status is okay.

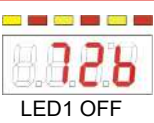
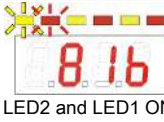
The table shows an example with the factory setting and with inverted status function for LED1. The switching points are defined as:

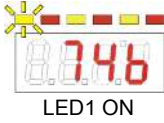
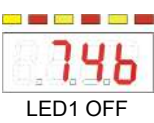
SP1 = 70 bar, rP1 = 65 bar
 SP2 = 80 bar, rP2 = 75 bar

	Factory setting	Status function LED 1 inverted	State	Status
A	 LED1 ON	 LED1 OFF	Pressure rises to > 70 bar PNP switching output 1 closed	OK
B	 LED2 and LED1 ON	 only LED2 ON	Pressure rises to > 80 bar PNP switching output 2 closed	Error
C	 LED1 ON	 LED1 OFF	Pressure falls to < 75 bar PNP switching output 2 open	OK
D	 LED1 OFF	 LED1 ON	Pressure falls to < 65 bar PNP switching output 1 open	Error

Here you can reverse the LED status function for a contact: the LED lights up if the contact is open, so below the minimum pressure, and the LED lighting up again indicates an "Error" status.

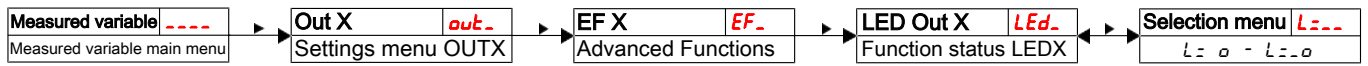

The options are:

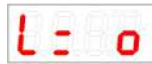

LED = output;

the LED lights up when the PNP switching output is closed.

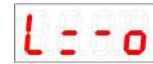

LED = -output;

the LED lights up when the PNP switching output is open.

NOTICE



The display function of the status LED affects event logging! Please note chapter “Diagnostic options”.

5.8 Analogue outputs

5.8.1 Analogue output x: Assigning the upper limit

Used to configure at which measurement to output the maximum analogue signal. This is configured in menu:

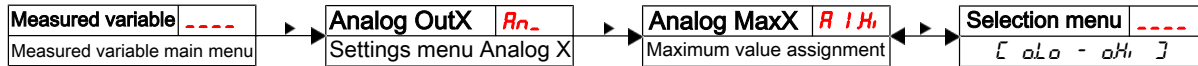

Note:

– The output range setting must not be less than 10 % of the measuring range: $A.Hi - A.Lo >= 10\% * (FH_i - FL_o)$

Setting range:

$[FL_o] \dots [FH_i]$

– If the range is set too low, the analogue value output may have grades.

5.8.2 Analogue output x: Lower limit assignment

Used to configure at which measurement to output the minimum analogue signal. This is configured in menu:

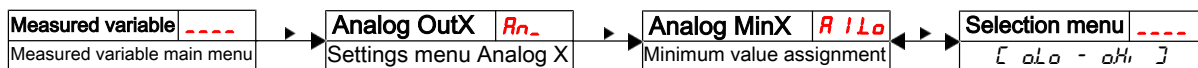

Note:

– The output range setting must not be less than 10 % of the measuring range: $A.Hi - A.Lo >= 10\% * (FH_i - FL_o)$

Setting range:

$[FL_o] \dots [FH_i]$

– If the range is set too low, the analogue value output may have grades.

5.8.3 Analogue output x: Signal type assignment

The analogue output can be defined as a voltage or current output with different value ranges. This is configured in menu:

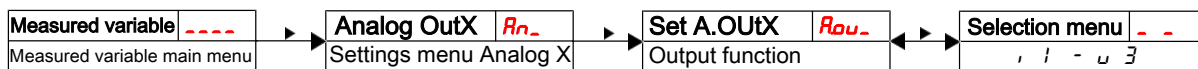

The options are:



4 mA to 20 mA



2 V to 10 V



0 V to 10 V



0 V to 5 V

5.8.4 Analogue output x: Testing the analogue output

The analogue output can be tested. The highest, mean and lowest analogue value can be output successively. This is configured in menu:

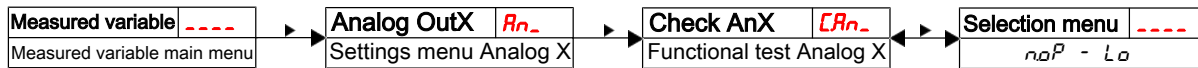

The options are:



Normal mode



Highest analogue value output



Mean analogue value output



Lowest analogue value output



Note:

- After completing the test, set the function to normal mode *noP*.

5.9 Diagnostic options

The device is able to log events for a switching output. The LED lighting up is considered an event. The logging of switching procedures therefore depends on how the LED switching function is configured.

The configuration and analysis can be carried out here.

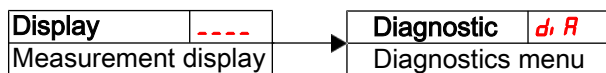

NOTICE



Only one switching output can be logged. The switching output to be logged is configured in menu item **Set Journal Out** (*5Jout*).

- Press the ▼ key to open the main menu.
- Select menu item *d, R* with the ▼ and ▲ keys.



From here you will be able to access various diagnostic values and measurement monitoring logs.

- Open the menu with the ► key.
You can now change or view the diagnostic settings.

5.9.1 View logbook

The last 6 events for the switching output being logged can be viewed here and all entries deleted:

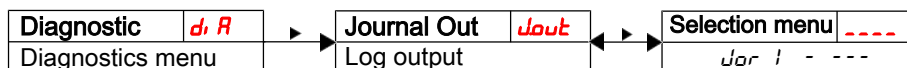

The journal entries will be displayed as:

- Most recent event *Jor 1* occurred x hours (h) / days (d) ago,
- Events 2 to 5 occurred x hours / days ago,
- The oldest event *Jor 6* occurred x hours / days ago,
- Delete function (---)

Example:

Jor 1 ⇔ 13h, key ▼
Jor 2 ⇔ 24h, key ▼, ▲
Jor 3 ⇔ 5.1h, key ▼, ▲
Jor 4 ⇔ 82h, key ▼, ▲
Jor 5 ⇔ nan 8, key ▼, ▲
Jor 6 ⇔ nan 8, key ▼, ▲
 ---, key ▲; ► = delete

* not yet populated, only 4 events have occurred



The information displayed will alternate between the index and time for entry x, e.g. *Jor 1* ↔ *1.4h* for the most recent event 1.4 hours ago.

Press the **▶** key to return to the submenu or use **▼**, **▲** to select the next journal entry.

Confirming the information with the **▶** key will delete the list of events and return to the submenu.

Note:

- If no events have been logged, the display will alternate between *Jor X* and *non.*

5.9.2 Maximum and minimum measurement

Used to view or delete the saved maximum and minimum measurement:

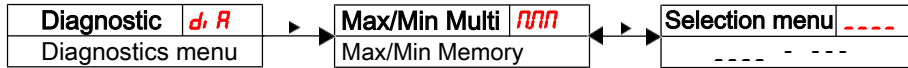

The journal entries will be displayed as:

- Maximum measurement,
- occurred x hours / days ago,
- Minimum measurement,
- occurred x hours / days ago,
- Delete function

Example:

150, key **▼**
8.4h, key **▼**, **▲**
60, key **▼**, **▲**
2.1h, key **▼**, **▲**
 ---, key **▲**; **▶** = delete

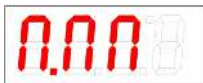

Press the **▶** key to return to the submenu or use **▼**, **▲** to select the next Journal entry.

Confirming the information with the **▶** key will delete the list of events and return to the submenu.

Menu order:
 Max. value,
 min.
 time value
 time
 delete

5.9.3 Define switching output to log

Used to select the switching output to be logged. Only one switching output can be logged.

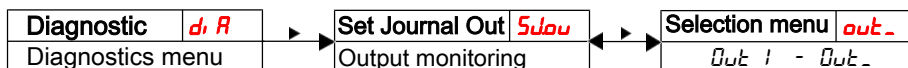

Switching output logging.

Options:
out 1 to *out X*

NOTICE



Values are backed up from volatile to non-volatile memory approx. every three hours.

5.9.4 Delay for storing the Min/Max measurement

A delay time for saving the minimum and maximum measurement can be set to record reliable values in unstable conditions. Here, enter the time span in seconds during which the signal must be continuously present before the measurement is logged.

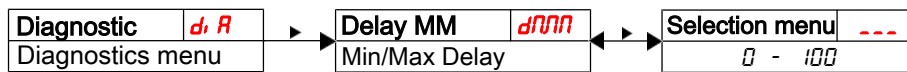

– Set the desired delay.

Setting range:
0...100 seconds

6 Cleaning and Maintenance

This device is maintenance-free.

The method for cleaning the devices must be adapted to the IP protection class of the devices. Do not use cleaners which could damage the device materials.

7 Service and repair

This chapter contains information on troubleshooting and correction should an error occur during operation.

Repairs to the unit must be performed by Bühler authorised personnel.

Please contact our Service Department with any questions:

Tel.: +49-(0)2102-498955 or your agent

If the equipment is not functioning properly after correcting any malfunctions and switching on the power, it must be inspected by the manufacturer. Please send the equipment inside suitable packaging to:

Bühler Technologies GmbH

- Reparatur/Service -

Harkortstraße 29

40880 Ratingen







Germany

Please also attach the completed and signed RMA decontamination statement to the packaging. We will otherwise be unable to process your repair order.

You will find the form in the appendix of these instructions, or simply request it by e-mail:

service@buehler-technologies.com.

7.1 Troubleshooting

Problem / Malfunction	Possible cause	Action
No display	– No supply voltage	– Check cable and replace, if necessary
Error messages on the display:		
Alternating between Err and Exxx: e.g.  ↔ 		
 Error 001	– Ambient temperature too low	– Maintain limits
 Error 002	– Ambient temperature too high	– Maintain limits
 Error 256	– Input signal too low – Connecting cable defective	– Maintain minimum signal level – Check connecting cable to the sensor and replace, if necessary
 Error 512	– Input signal too high	– Maintain maximum signal level
 Error 1024	– Second plug has no supply voltage	– Check the supply voltage for the second plug. – Be sure to switch on or plug in the power supply for the second plug before or shortly after the first.
	– Internal error	– Please contact customer service

Possible errors

Problem / Malfunction	Possible cause	Action
Switching output not triggering when exceeding limits	– Switching output configured incorrectly	– In submenu Цоух : “Test Switching Output” to ensure normal mode
	– Switching output defect	– In submenu Цоух : “Test Switching Output” to test the desired switching output
Switching output constantly switching	– Switching output configured incorrectly	– In submenu Цоух : “Test Switching Output” to ensure normal mode
	– Switching output defect	– In submenu Цоух : “Test Switching Output” to test the desired switching output
The analogue doesn't receive the full/correct output current	– Wrong signal type set	– In submenu Рох : Check and if necessary set the correct signal type (current/voltage output)
	– Load too high (current output)	– Reduce load to permissible value
Analogue output doesn't change the output signal when the input signal changes	– Analogue output configured incorrectly	– In submenu ЦРоух : „Test Analogue Output“ to ensure normal mode

7.2 Spare parts and accessories

Item no. 4-pin	Item no. 5-pin	Item no. 8-pin	Description
9144 05 0010	9144 05 0016	9144 05 0048	Connecting cable M12x1, 1.5 m, angular coupling and straight plug
9144 05 0046	9144 05 0017	9144 05 0049	Connecting cable M12x1, 3.0 m, angular coupling and straight plug
9144 05 0047	9144 05 0018	9144 05 0033	Connecting cable M12x1, 5.0 m, angular coupling and strands

8 Disposal

The applicable national laws must be observed when disposing of the products. Disposal must not result in a danger to health and environment.

The crossed out wheelie bin symbol on Bühler Technologies GmbH electrical and electronic products indicates special disposal notices within the European Union (EU).



The crossed out wheelie bin symbol indicates the electric and electronic products bearing the symbol must be disposed of separate from household waste. They must be properly disposed of as waste electrical and electronic equipment.

Bühler Technologies GmbH will gladly dispose of your device bearing this mark. Please send your device to the address below for this purpose.

We are obligated by law to protect our employees from hazards posed by contaminated devices. Therefore please understand that we can only dispose of your waste equipment if the device is free from any aggressive, corrosive or other operating fluids dangerous to health or environment. **Please complete the "RMA Form and Decontamination Statement", available on our website, for every waste electrical and electronic equipment. The form must be applied to the packaging so it is visible from the outside.**

Please return waste electrical and electronic equipment to the following address:

Bühler Technologies GmbH
WEEE
Harkortstr. 29
40880 Ratingen
Germany

Please also observe data protection regulations and remember you are personally responsible for the returned waste equipment not bearing any personal data. Therefore please be sure to delete your personal data before returning your waste equipment.

9 Appendices

9.1 Multitronik Technical Data

Version		
Housing material	PA	
Mount	35 mm top-hat rail mounting	
Weight	approx. 100 g	
Degree of protection	IP65	
Analysis/display electronics		
Display	4 character 7 segment LED	
Operation	Via 3 keys	
Memory	Min. / Max. Data memory	
Starting current input	approx. 100 mA for 100 ms	
Current input during operation	approx. 50 mA (without current- and switching outputs)	
Supply voltage (U_B)	10 – 30 V DC (nominal voltage 24 V DC)	
Ambient temperature	-20 °C to +70 °C	
Display units	Level	Temperature
	% , cm , L , i , Gal	°C / °F
Display range	adjustable	-20 °C to +120 °C
Alarm setting range	e.g. 0 – 100 %	0 °C to 100 °C
Display accuracy	± 1 % from end value ± 1 % from end value	
Input values		
Display units	b (bar), P (psi), °C, °F, L (litre) as well as various other letters and symbols to choose from	
Input signal	-4 – 20 mA	

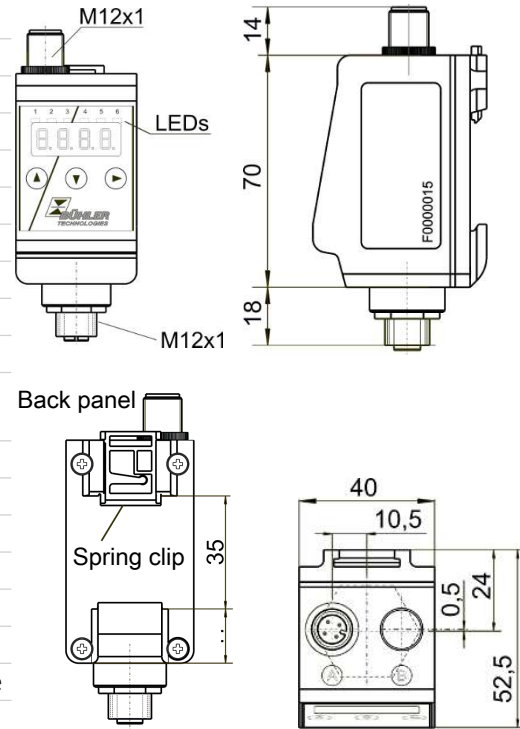

Optional switching outputs

	-1D1S	-2S	-4S	-6S
Plug (base)	1 x M12 – 4-pin	1 x M12 – 4-pin	1 x M12 – 8-pin	1 x M12 – 8-pin
Switching outputs	IO-Link and 1x freely programmable (set to level or temperature)	2 x freely programmable*	4 x freely programmable*	6 x freely programmable*
Alarm memory	with 1 x assignable to alarm logbook	with 1 x assignable to alarm logbook	with 1 x assignable to alarm logbook	with 1 x assignable to alarm logbook
Contact load	max. 1 A total (output 1 max 0.2 A)			

*also programmable as frequency output

	-1S-K	-2S-K	-4S-K
Plug (base)	1 x M12 – 4-pin	1 x M12 – 5-pin	1 x M12 – 8-pin
Switching outputs	1 x freely programmable	2 x freely programmable	4 x freely programmable
Alarm memory	with 1 x assignable to alarm logbook	with 1 x assignable to alarm logbook	with 1 x assignable to alarm logbook
Contact load	max. 1 A total (output 1 max 0.2 A)		

*also programmable as frequency output

Analogue outputs

Programmable as	1 x 4 – 20 mA, 2 – 10 V DC, 0 – 10 V DC, 0 – 5 V DC	1 x 4 – 20 mA, 2 – 10 V DC, 0 – 10 V DC, 0 – 5 V DC	1 x 4 – 20 mA, 2 – 10 V DC, 0 – 10 V DC, 0 – 5 V DC
Max. load Ω as current output	$(U_B - 8V) / 0.02 A$	$(U_B - 8V) / 0.02 A$	$(U_B - 8V) / 0.02 A$
Min. input load as voltage input	10 k Ω	10 k Ω	10 k Ω

9.2 Multitronik standard pin assignment

Remote display sensor supply

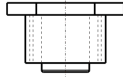
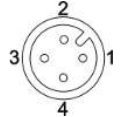
Panel jack	1x M12x1 4-pin
	
Panel jack	
Pin	
1	+24 V DC
3 / 4	4 - 20 mA

Plug connections

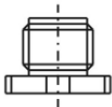
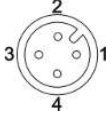
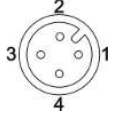
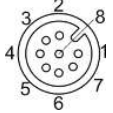
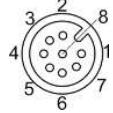
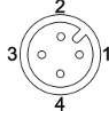
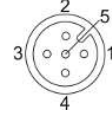
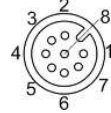
Version	1D1S	2S	4S	6S	1S-K	2S-K	4S-K
Panel plug	1x M12x1 (base)						
	4-pin	4-pin	8-pin	8-pin	4-pin	5-pin	8-pin
							
Panel plug							
Pin							
1	+24 V DC	+24 V DC	+24 V DC	+24 V DC	+24 V DC	+24 V DC	+24 V DC
2	S2 (PNP)	S2 (PNP)	S2 (PNP)	S2 (PNP)	Analogue (out)	S2 (PNP)	S2 (PNP)
3	GND	GND	GND	GND	GND	GND	GND
4	C/Q (IO-Link)	S1 (PNP)	S1 (PNP)	S1 (PNP)	S1 (PNP)	S1 (PNP)	S1 (PNP)
5			S3 (PNP)	S3 (PNP)		Analogue (out)	S3 (PNP)
6			S4 (PNP)	S4 (PNP)			S4 (PNP)
7				S5 (PNP)			Analogue (out)
8				S6 (PNP)			

9.3 Current settings

Switching outputs	Basic Settings	Diagnostics
SP1 / rP1	PLu1	Sduu
dS1 / dr1 / ou1	PLH1	dnnn
SP2 / rP2	PLo	
dS2 / dr2 / ou2	di S	
SP3 / rP3	Loc	
dS3 / dr3 / ou3		
SP4 / rP4		
dS4 / dr4 / ou4		
SP5 / rP5		
dS5 / dr5 / ou5		
SP6 / rP6		
dS6 / dr6 / ou6		
Analogue outputs		
R1H1 / R1Lo / Rou1		
R2H1 / R2Lo / Rou2		

Date: _____

Signature: _____

9.4 Display ranges

Name	Menu/Unit	Display	Range from/ with unit	Range to/ with unit
Temperature				
°C	C	C	-100 °C	999 °C
°F	F	F	-100 °F	999 °F
Pressure				
Bar	bAr	b	-100 Bar	999 Bar
mBar	mbAr	none	-1000	9999
Mpa	mPA	P	-10.0 Mpa	99.9 Mpa
psi	PSI	none	-1000	9999
Liquid level				
Percent	- I -	-	-100 %	999 %
cm	cn	c	-100 cm	999 cm
inch	i n	,	-100 inch	999 inch
Litre	L, L	L	-100 Litre	999 Litre
Gallon	LRI	C	-100 gallons	999 gallons
N/A				
none	non	none	-1000	9999
none	non1	none	-100.0	999.9
none	non2	none	-10.00	99.99

9.5 Display resolution

Range $x = |\text{Max} - \text{Min}|$

none (*non*), psi, mBar
(no decimal places)

°C, °F, bar, percent, cm, inch, litre, gallon, *non*
(up to 1 decimal place)
cm, inch, litre, gallon

Range x	Resolution	Range x	Resolution
$x < 500$	1	$x < 50$	0.1
$500 \leq x < 1000$	2	$50 \leq x < 100$	0.2
$1000 \leq x < 2000$	5	$100 \leq x < 200$	0.5
$2000 \leq x < 5000$	10	$200 \leq x < 500$	1
$5000 \leq x < 10000$	20	$500 \leq x < 1000$	2
$10000 \leq x$	50	$1000 \leq x$	5

Mpa
(up to 2 decimal places)

none (*non !*)
(1 fixed-point number)

Range x	Resolution	Range x	Resolution
$x < 5$	0.01	$x < 50$	0.1
$5 \leq x < 10$	0.02	$50 \leq x < 100$	0.2
$10 \leq x < 20$	0.05	$100 \leq x < 200$	0.5
$20 \leq x < 50$	0.1	$200 \leq x < 500$	1
$50 \leq x < 100$	0.2	$500 \leq x < 1000$	2
$100 \leq x$	0.5	$1000 \leq x$	5

none (*non²*)
(2 fixed-point numbers)

Range x	Resolution
$x < 5$	0.01
$5 \leq x < 10$	0.02
$10 \leq x < 20$	0.05
$20 \leq x < 50$	0.1
$50 \leq x < 100$	0.2
$100 \leq x$	0.5

Example no unit: Min = 100, Max = 1500 -> $x = 1500 - 100 = 1400$ -> Resolution = 5

Example Temperature: Min = 0°C, Max. = 100°C -> $x = 100^\circ\text{C} - 0^\circ\text{C} = 100^\circ\text{C}$ -> Resolution = 0.5°C

9.6 Menu Sequence Overview

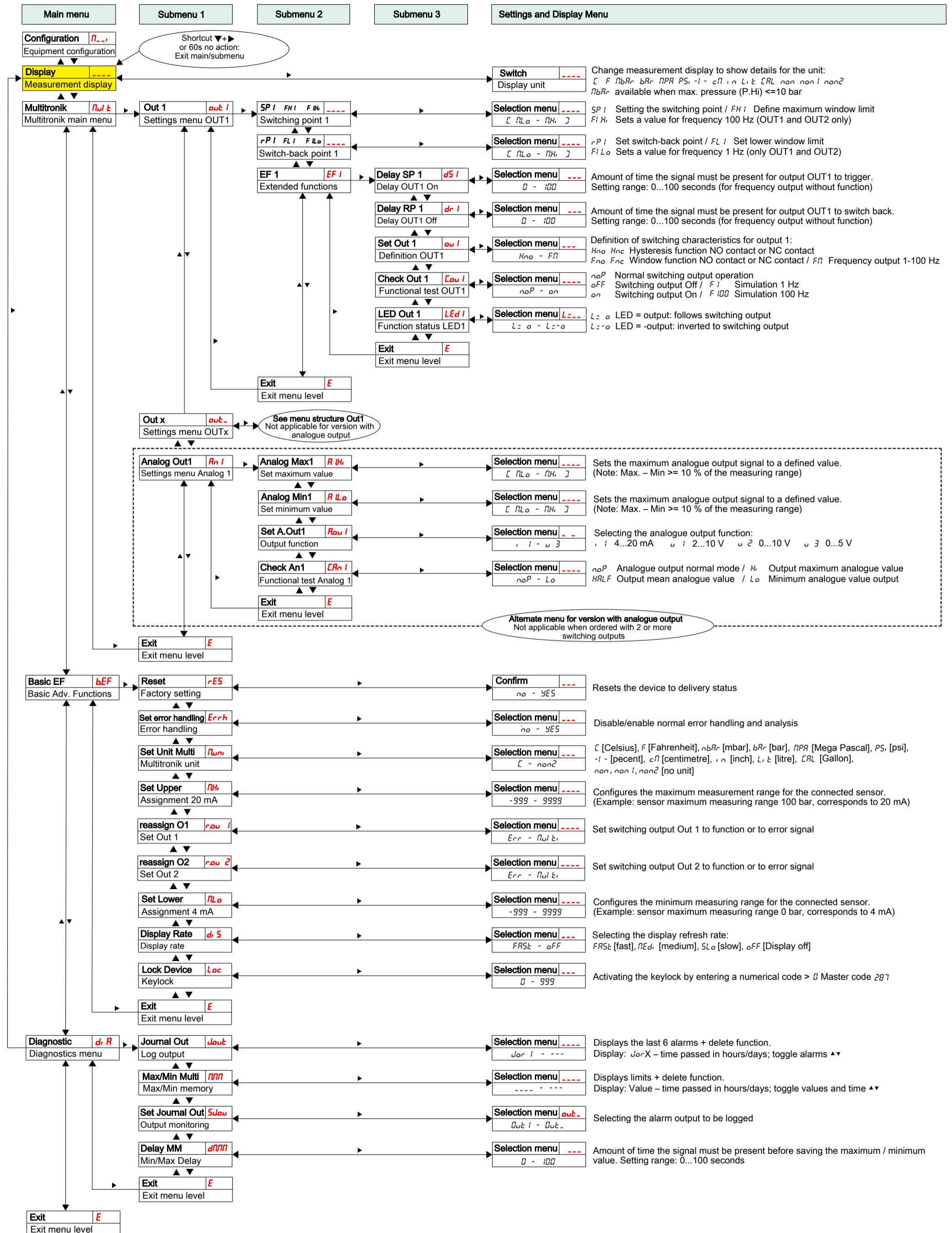

10 Attached documents

- Declaration of conformity: KX180020
- RMA - Decontamination Statement

EU-Konformitätserklärung
EU-declaration of conformity



Hiermit erklärt Bühler Technologies GmbH,
dass die nachfolgenden Produkte den
wesentlichen Anforderungen der Richtlinie

*Herewith declares Bühler Technologies GmbH
that the following products correspond to the
essential requirements of Directive*

2014/30/EU
(Elektromagnetische Verträglichkeit / *electromagnetic compatibility*)

in ihrer aktuellen Fassung entsprechen.

in its actual version.

Produkt / products: Anzeige- und Steuergerät / *Display and control unit*
Typ / type: Multitronik

Das Betriebsmittel dient dem Anschluss unterschiedlicher Sensoren zur Füllstands-, Temperatur- oder
Drucküberwachung.
The equipment provides connectivity to a number of sensors for level, temperature, and pressure control.

Das oben beschriebene Produkt der Erklärung erfüllt die einschlägigen
Harmonisierungsrechtsvorschriften der Union:
*The object of the declaration described above is in conformity with the relevant Union harmonisation
legislation:*

EN 61326-1:2013

Die alleinige Verantwortung für die Ausstellung dieser Konformitätserklärung trägt der Hersteller.
This declaration of conformity is issued under the sole responsibility of the manufacturer.

Dokumentationsverantwortlicher für diese Konformitätserklärung ist Herr Stefan Eschweiler mit
Anschrift am Firmensitz.
*The person authorised to compile the technical file is Mr. Stefan Eschweiler located at the company's
address.*

Ratingen, den 20.04.2016

A handwritten signature in black ink, appearing to read 'Stefan Eschweiler'.

Stefan Eschweiler
Geschäftsführer – *Managing Director*

A handwritten signature in blue ink, appearing to read 'Frank Pospiech'.

Frank Pospiech
Geschäftsführer – *Managing Director*

UK Declaration of Conformity



The manufacturer Bühler Technologies GmbH declares, under the sole responsibility, that the product complies with the requirements of the following UK legislation:

Electromagnetic Compatibility Regulations 2016

Product: Display and control unit
Type: Multitronik

The equipment provides connectivity to a number of sensors for level, temperature, and pressure control.

The object of the declaration described above is in conformity with the relevant designated standards:

EN 61326-1:2013

Ratingen in Germany, 01.11.2022

A handwritten signature in black ink, appearing to read 'Stefan Eschweiler', written over a horizontal line.

Stefan Eschweiler
Managing Director

A handwritten signature in blue ink, appearing to read 'Frank Pospiech', written over a horizontal line.

Frank Pospiech
Managing Director

RMA-Formular und Erklärung über Dekontaminierung

RMA-Form and explanation for decontamination



RMA-Nr./ RMA-No.

Die RMA-Nr. bekommen Sie von Ihrem Ansprechpartner im Vertrieb oder Service. Bei Rücksendung eines Altgeräts zur Entsorgung tragen Sie bitte in das Feld der RMA-Nr. "WEEE" ein./ You may obtain the RMA number from your sales or service representative. When returning an old appliance for disposal, please enter "WEEE" in the RMA number box.

Zu diesem Rücksendeschein gehört eine Dekontaminierungserklärung. Die gesetzlichen Vorschriften schreiben vor, dass Sie uns diese Dekontaminierungserklärung ausgefüllt und unterschrieben zurücksenden müssen. Bitte füllen Sie auch diese im Sinne der Gesundheit unserer Mitarbeiter vollständig aus./ This return form includes a decontamination statement. The law requires you to submit this completed and signed decontamination statement to us. Please complete the entire form, also in the interest of our employee health.

Firma/ Company

Firma/ Company

Straße/ Street

PLZ, Ort/ Zip, City

Land/ Country

Gerät/ Device

Anzahl/ Quantity

Auftragsnr./ Order No.

Ansprechpartner/ Person in charge

Name/ Name

Abt./ Dept.

Tel./ Phone

E-Mail

Serien-Nr./ Serial No.

Artikel-Nr./ Item No.

Grund der Rücksendung/ Reason for return

- Kalibrierung/ Calibration Modifikation/ Modification
 Reklamation/ Claim Reparatur/ Repair
 Elektroaltgerät/ Waste Electrical & Electronic Equipment (WEEE)
 andere/ other

bitte spezifizieren/ please specify

Ist das Gerät möglicherweise kontaminiert?/ Could the equipment be contaminated?

- Nein, da das Gerät nicht mit gesundheitsgefährdenden Stoffen betrieben wurde./ No, because the device was not operated with hazardous substances.
 Nein, da das Gerät ordnungsgemäß gereinigt und dekontaminiert wurde./ No, because the device has been properly cleaned and decontaminated.
 Ja, kontaminiert mit:/ Yes, contaminated with:



explosiv/
explosive



entzündlich/
flammable



brandfördernd/
oxidizing



komprimierte
Gase/
compressed
gases



ätzend/
caustic



giftig,
Lebensgefahr/
poisonous, risk
of death



gesundheitsge-
fährdend/
harmful to
health



gesund-
heitsschädlich/
health hazard



umweltge-
fährdend/
environmental
hazard

Bitte Sicherheitsdatenblatt beilegen!/ Please enclose safety data sheet!

Das Gerät wurde gespült mit:/ The equipment was purged with:

Diese Erklärung wurde korrekt und vollständig ausgefüllt und von einer dazu befugten Person unterschrieben. Der Versand der (dekontaminierten) Geräte und Komponenten erfolgt gemäß den gesetzlichen Bestimmungen.

This declaration has been filled out correctly and completely, and signed by an authorized person. The dispatch of the (decontaminated) devices and components takes place according to the legal regulations.

Falls die Ware nicht gereinigt, also kontaminiert bei uns eintrifft, muss die Firma Bühler sich vorbehalten, diese durch einen externen Dienstleister reinigen zu lassen und Ihnen dies in Rechnung zu stellen.

Should the goods not arrive clean, but contaminated, Bühler reserves the right, to commission an external service provider to clean the goods and invoice it to your account.

Firmenstempel/ Company Sign

Datum/ Date

rechtsverbindliche Unterschrift/ Legally binding signature



Vermeiden von Veränderung und Beschädigung der einzusendenden Baugruppe

Die Analyse defekter Baugruppen ist ein wesentlicher Bestandteil der Qualitätssicherung der Firma Bühler Technologies GmbH. Um eine aussagekräftige Analyse zu gewährleisten muss die Ware möglichst unverändert untersucht werden. Es dürfen keine Veränderungen oder weitere Beschädigungen auftreten, die Ursachen verdecken oder eine Analyse unmöglich machen.

Umgang mit elektrostatisch sensiblen Baugruppen

Bei elektronischen Baugruppen kann es sich um elektrostatisch sensible Baugruppen handeln. Es ist darauf zu achten, diese Baugruppen ESD-gerecht zu behandeln. Nach Möglichkeit sollten die Baugruppen an einem ESD-gerechten Arbeitsplatz getauscht werden. Ist dies nicht möglich sollten ESD-gerechte Maßnahmen beim Austausch getroffen werden. Der Transport darf nur in ESD-gerechten Behältnissen durchgeführt werden. Die Verpackung der Baugruppen muss ESD-konform sein. Verwenden Sie nach Möglichkeit die Verpackung des Ersatzteils oder wählen Sie selber eine ESD-gerechte Verpackung.

Einbau von Ersatzteilen

Beachten Sie beim Einbau des Ersatzteils die gleichen Vorgaben wie oben beschrieben. Achten Sie auf die ordnungsgemäße Montage des Bauteils und aller Komponenten. Versetzen Sie vor der Inbetriebnahme die Verkabelung wieder in den ursprünglichen Zustand. Fragen Sie im Zweifel beim Hersteller nach weiteren Informationen.

Einsenden von Elektroaltgeräten zur Entsorgung

Wollen Sie ein von Bühler Technologies GmbH stammendes Elektroprodukt zur fachgerechten Entsorgung einsenden, dann tragen Sie bitte in das Feld der RMA-Nr. „WEEE“ ein. Legen Sie dem Altgerät die vollständig ausgefüllte Dekontaminierungserklärung für den Transport von außen sichtbar bei. Weitere Informationen zur Entsorgung von Elektroaltgeräten finden Sie auf der Webseite unseres Unternehmens.

Avoiding alterations and damage to the components to be returned

Analysing defective assemblies is an essential part of quality assurance at Bühler Technologies GmbH. To ensure conclusive analysis the goods must be inspected unaltered, if possible. Modifications or other damages which may hide the cause or render it impossible to analyse are prohibited.

Handling electrostatically conductive components

Electronic assemblies may be sensitive to static electricity. Be sure to handle these assemblies in an ESD-safe manner. Where possible, the assemblies should be replaced in an ESD-safe location. If unable to do so, take ESD-safe precautions when replacing these. Must be transported in ESD-safe containers. The packaging of the assemblies must be ESD-safe. If possible, use the packaging of the spare part or use ESD-safe packaging.

Fitting of spare parts

Observe the above specifications when installing the spare part. Ensure the part and all components are properly installed. Return the cables to the original state before putting into service. When in doubt, contact the manufacturer for additional information.

Returning old electrical appliances for disposal

If you wish to return an electrical product from Bühler Technologies GmbH for proper disposal, please enter "WEEE" in the RMA number box. Please attach the fully completed decontamination declaration form for transport to the old appliance so that it is visible from the outside. You can find more information on the disposal of old electrical appliances on our company's website.

