



Sample gas cooler

Series EGK 1 Ex2

Installation and Operation Instructions

Original instructions





Bühler Technologies GmbH, Harkortstr. 29, D-40880 Ratingen
Tel. +49 (0) 21 02 / 49 89-0, Fax: +49 (0) 21 02 / 49 89-20
Internet: www.buehler-technologies.com
E-Mail: analyse@buehler-technologies.com

Read this instruction carefully prior to installation and/or use. Pay attention particularly to all advises and safety instructions to prevent injuries. Bühler Technologies can not be held responsible for misusing the product or unreliable function due to unauthorised modifications.

All rights reserved. Bühler Technologies GmbH 2024

Document information

Document No.....BE450022
Version.....03/2024

Contents

1	Introduction	2
1.1	Intended Use	2
1.1.1	Please note for this device:	2
1.2	Types	2
1.3	Type plate	2
1.4	Scope of delivery	2
1.5	Ordering instructions	3
2	Safety instructions	4
2.1	Important notices	4
2.2	General hazard warnings	5
2.3	Equipment Ambient Temperatures	6
3	Transport and storage	7
4	Installation and connection	8
4.1	Installation site requirements	8
4.2	Installation	8
4.2.1	Peristaltic Pump Connection (Optional)	8
4.2.2	Connecting the heat exchanger	9
4.3	Electrical connections	9
4.4	Signal Output	10
4.5	Testing Electric Strength	11
5	Operation and control	12
5.1	Description of functions	12
5.2	Use of menu functions	13
5.2.1	Lock Menu	13
5.2.2	Menu navigation overview	14
5.3	Description of menu functions	15
5.3.1	Main menu	15
5.3.2	Submenu 1	16
5.3.3	Submenu 1 (global settings)	16
5.3.4	Set favourite menu	17
6	Maintenance	18
7	Service and repair	19
7.1	Troubleshooting	19
7.1.1	Error messages on the display	20
7.2	Safety instructions	20
7.3	Cleaning and removal of the heat exchanger	21
7.4	Replacing the hoses of the peristaltic pump (option)	21
7.5	Spare Parts	22
7.5.1	Consumables and accessories	22
8	Disposal	23
9	Appendices	24
9.1	Gas cooler technical data	24
9.2	Technical Data - Options	24
9.3	Performance data	25
9.4	Diagram typical installation	25
9.5	Heat exchanger	25
9.5.1	Heat exchanger description	25
9.5.2	Heat exchanger overview	26
9.6	Dimensions (mm)	26
10	Attached documents	27

1 Introduction

1.1 Intended Use

This unit is intended for industrial use in gas analysis systems. It's an essential component for conditioning the sample gas to protect the analysis instrument from residual moisture in the sample gas.

This device is intended for use in areas with explosive atmospheres category 3G, explosion group IIC, temperature class T4.

Please note the specifications in the data sheet on the specific intended use, existing material combinations, as well as pressure and temperature limits.

The unit bears the following explosion protection markings:

Atex:  II 3G Ex ec nA nC IIC T4 Gc

IECEX: Ex ec nA nC IIC T4 Gc

EAC Ex: 2Ex e nA nC IIC T4

1.1.1 Please note for this device:

The equipment must be installed in a housing which at a minimum meets EPL Gc.

1.2 Types

The device is delivered with different configurations. The part number given on the type plate informs you about the specific configuration of your device.

1.3 Type plate

Example IECEX:

Manufacturer and address	→	Bühler Technologies GmbH Harkortstr. 29 D-40880 Ratingen
Model designation	→	Compressor Sample gas cooler EGK 1 Ex2
Order no., item no.	→	000073513 4563211222862000 001
Blast protection marking	→	 II 3G Ex ec nA nC IIC T4 Gc
Electrical supply	→	Voltage: 230V 50Hz
IECEX certificate number	→	IECEX IBE 17.0023X
Year of manufacture	→	Read manual! Year: 2018



Example EAC Ex:

Manufacturer including address	→	Bühler Technologies GmbH Harkortstr. 29 D-40880 Ratingen Прочтите инструкцию!
Type designation	→	EGK 1 Ex2
Serial no.	→	000082048 160230 001
Explosion prevention mark	→	2Ex e nA nC IIC T4
Voltage	→	230V 50Hz
Temperature specifications	→	+5°C ≤ Ta ≤ 50°C
EAC Ex certificate number	→	TC RUC-DE.MIO62.B.05995
Year of manufacture	→	12 / 2018



1.4 Scope of delivery

- Cooler
- Product documentation
- Connection-/mounting accessories (optional)

1.5 Ordering instructions

The item number is a code for the configuration of your unit. Please use the following model key:

Please note: Every individual gas path must be equipped with peristaltic pump or condensate drain.

4563	211	X	X	X	X	X	X	0	0	0	Product Characteristics
											Certifications
	2										ATEX Zone 2
	5										EAC Ex
											Voltage
	1										115 V, 60 Hz
	2										230 V, 50 Hz
											Heat exchanger
		1	1	0							1 gas path, stainless steel/ (TS), metric
		1	1	5							1 gas path, stainless steel/ (TS-I), US
		1	2	0							1 gas path, glass/ (TG), metric
		1	2	5							1 gas path, glass/ (TG), US hoses
		1	3	0							1 gas path, PVDF/ (TV), metric
		1	3	5							1 gas path, PVDF/ (TV-I), US
		2	6	0							2 gas paths, stainless steel/ (DTS), metric
		2	6	1							2 gas paths, stainless steel/ (DTS-6) ¹⁾ , metric
		2	6	5							2 gas paths, stainless steel/ (DTS-I), US
		2	6	6							2 gas paths, stainless steel/ (DTS-6-I) ¹⁾ , US
		2	7	0							2 gas paths, glass/ (DTG), metric
		2	7	5							2 gas paths, glass/ (DTG-I), US hoses
		2	8	0							2 gas paths, PVDF/ (DTV) ¹⁾ , metric
		2	8	5							2 gas paths, PVDF/ (DTV-I) ¹⁾ , US
											Condensate drain ²⁾
				0							without condensate drain
				1							Peristaltic pump CPsingle with hose connection 90° angle ²⁾
				2							2 peristaltic pumps CPsingle with 90° elbow hose connection ²⁾
				3							CPsingle peristaltic pump with screw-in hose connection ²⁾
				4							2 peristaltic pumps CPsingle with screw-in hose connection ²⁾

¹⁾ Condensate outlets only suitable for connecting peristaltic pumps.

²⁾ Each gas path equipped with a peristaltic pump. The supply voltage corresponds with that of the main unit.

2 Safety instructions

2.1 Important notices

This unit may only be used if:

- The product is being used under the conditions described in the operating- and installation instructions, used according to the nameplate and for applications for which it is intended. Any unauthorized modifications to the unit will void the warranty provided by Bühler Technologies GmbH,
- The specifications and markings in the type plate must be observed,
- The threshold values in the data sheet and the instructions must be observed,
- Monitoring equipment / protection devices must be connected correctly,
- Service and repair work not described in these instructions are performed by Bühler Technologies GmbH,
- Genuine replacement parts must be used.

Erecting electrical systems in explosive areas requires compliance with the regulation IEC/EN 60079-14.

Additional national regulations pertaining to initial operation, operation, maintenance, repairs and disposal must be observed.

These operating instructions are a part of the equipment. The manufacturer reserves the right to change performance-, specification- or technical data without prior notice. Please keep these instructions for future reference.

Signal words for warnings

DANGER	Signal word for an imminent danger with high risk, resulting in severe injuries or death if not avoided.
WARNING	Signal word for a hazardous situation with medium risk, possibly resulting in severe injuries or death if not avoided.
CAUTION	Signal word for a hazardous situation with low risk, resulting in damaged to the device or the property or minor or medium injuries if not avoided.
NOTICE	Signal word for important information to the product.

Warning signs

These instructions include the following warnings:

	General warning sign		General mandatory sign
	Voltage warning		Unplug from mains
	Warning not to inhale toxic gases		Wear respiratory equipment
	Warning of corrosive substances		Wear a safety mask
	Warning of explosion hazard		Wear gloves
	Warning of hot surfaces		

2.2 General hazard warnings

The equipment must be installed by a professional familiar with the safety requirements and risks.

Be sure to observe the safety regulations and generally applicable rules of technology relevant for the installation site. Prevent malfunctions and avoid personal injuries and property damage.

The operator of the system must ensure:









- Safety notices and operating instructions are available and observed,
- The respective national accident prevention regulations are observed,
- The permissible data and operational conditions are maintained,
- Safety guards are used and mandatory maintenance is performed,
- Legal regulations are observed during disposal,
- compliance with national installation regulations.

Maintenance, Repair

Please note during maintenance and repairs:

- Repairs to the unit must be performed by Bühler authorised personnel.
- Only perform conversion-, maintenance or installation work described in these operating and installation instructions.
- Always use genuine spare parts.
- Do not install damaged or defective spare part. If necessary, visually inspect prior to installation to determine any obvious damage to the spare parts.

Always observe the applicable safety and operating regulations in the respective country of use when performing any type of maintenance.

NOTICE	When used in explosive areas	
	Regulation IEC/EN 60079-14 must be observed when erecting electrical systems in explosive areas. Additional national regulations pertaining to initial operation, operation, maintenance, repairs and disposal must be observed.	
DANGER	Electrical voltage	
	Electrocution hazard. a) Disconnect the device from power supply. b) Make sure that the equipment cannot be reconnected to mains unintentionally. c) The device must be opened by trained staff only. d) Regard correct mains voltage.	
DANGER	Toxic, corrosive condensate	
 	a) Protect yourself from toxic, corrosive condensate when performing any type of work. b) Wear appropriate protective equipment. c) Please note the national safety rules!	 
DANGER	Explosion hazard	
	Life and explosion risk may result from gas leakage due to improper use. a) Use the devices only as described in this manual. b) Regard the process conditions. c) Check tubes and hoses for leakage.	

DANGER



Danger to life and explosion during installation and maintenance

The unit must not be worked on (assembly, installation, maintenance) in explosive atmospheres.

DANGER



Use in explosive areas

Flammable gasses could ignite or explode. Avoid the following hazard sources:

Application area

Never operate the gas cooler outside the specifications. Extracting gases or gas mixtures which are also explosive in the absence of air is prohibited.

Electrostatic charge (sparking)!

The equipment may only be used where normal operating conditions do not frequently produce flammable, electrostatic discharge.

Always clean plastic housing parts and decals with a damp cloth.

2.3 Equipment Ambient Temperatures

The equipment may be operated within the following temperature range when observing the specifications in these operating instructions:

$$5\text{ °C} < T_{\text{amb}} < 50\text{ °C} \quad (41\text{ °F} < T_{\text{amb}} < 122\text{ °F})$$

3 Transport and storage

Only transport the product inside the original packaging or a suitable alternative.

The equipment must be protected from moisture and heat when not in use. It must be stored in a covered, dry and dust-free room at a temperature of -20 °C to 60 °C (-4 °F to 140 °F).

4 Installation and connection

NOTICE

Accessories may limit critical operating parameters of the base unit



Adding accessories may limit critical operating parameters. Ambient temperatures, zone classifications, explosion groups, temperature classes or chemical resistances of accessories may vary from the base unit.

Always include all technical data in the operating instructions and data sheets of all components in the safety assessment.

4.1 Installation site requirements

The unit is intended for wall-mounted or table-top use in enclosed areas. Adequate protection from the weather must be provided when used outdoors.

Install the unit leaving enough room below the cooler to discharge the condensate. Leave room above for the gas supply.

Be sure to maintain the approved ambient temperature. Do not obstruct the convection of the cooler. The vents must have enough room to the next obstacle. The distance must especially be a minimum of 10 cm on the air outlet side.

Ensure adequate ventilation when installing in enclosed housings, e.g. analyser cabinets. If the convection is inadequate, we recommend aerating the cabinet or installing a fan to lower the inside temperature.

4.2 Installation

Run the gas supply to the cooler with a downward slope. The gas inputs are marked in red and additionally labelled "IN".

If a large amount of condensate accumulates we recommend using a condensate pre-separator with automatic condensate drain. Our condensate pre-separators 11 LD spec., AK 20 V or model 165 SS are suitable solutions.

Glass vessels and automatic condensate drains are available for draining condensate for external mounting below the unit. When using automatic condensate drains, the sample gas pump must be installed ahead of the cooler (pressure operation) to ensure proper function of the condensate drain.

If the sample gas pump is located at the cooler outlet (suction operation), we recommend using glass condensate traps or peristaltic pumps.

Connecting the condensate drains

Depending on the material, build a connecting line with fittings and tubing or hose between the heat exchanger and condensate drain. For stainless steel the condensate drain can be suspended directly to the connecting tube, for hoses the condensate drain must be secured separately using a clamp.

The condensate drain can be mounted directly to the heat exchanger.

Condensate lines must always be installed with a slope and a minimum inside diameter of DN 8/10 (5/16").

The DTV heat exchanger cannot be operated in conjunction with an automatic condensate drain.

4.2.1 Peristaltic Pump Connection (Optional)

Coolers ordered with attached peristaltic pumps already have these installed and wired. Heat exchangers ordered at the same time are already installed and connected to the peristaltic pumps.

NOTICE



Installing peristaltic **pumps** CPsingle / CPdouble limits the maximum permissible **operating pressure** in the system!

Operating pressure \leq 1 bar

A peristaltic pump may also be installed away from the cooler. A mounting angle is available for mounting the pump directly below the cooler. Mounts for securing the angle directly to the cooler are designated.

4.2.2 Connecting the heat exchanger

CAUTION



Explosion hazard

Before using any accessories with the sample gas cooler, verify these parts are suitable for the purpose and use in explosive atmospheres.
Please note, accessories may limit use of the sample gas cooler with respect to explosion protection.

The gas inputs are marked in red.

On glass heat exchangers the correct position of the seal is important when connecting the gas lines (see image). The seal consists of a silicone ring with a PTFE sleeve. The PTFE side must face the glass thread.

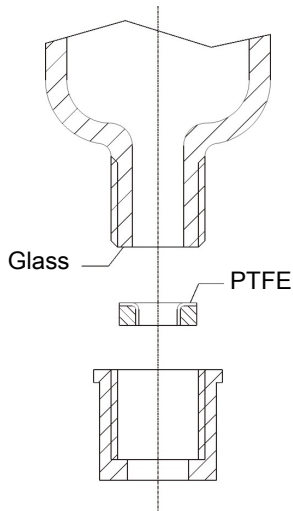

Pay attention to the appropriate spanner size when selecting fittings for stainless steel heat exchangers.

TS/TS-I gas connections: SW 17

TS/TS-I condensate out connections: SW 22

4.3 Electrical connections

The operator must install an external separator for the device which is clearly assigned to this device.

This separator

- must be located near the device,
- must be easy for the operator to reach,
- must comply with IEC 60947-1 and IEC 60947-3,
- must separate all live conductors and the status output, and
- must not be attached to the power feed.

The mains supply of the device must be fused according to the specifications under technical data.

WARNING



Hazardous electrical voltage

The device must be installed by trained staff only.

CAUTION



Wrong mains voltage

Wrong mains voltage may damage the device.
Regard the correct mains voltage as given on the type plate.

WARNING



High voltage

Damage to the device in case of insulation testing
Do not proceed insulation tests with high voltage to the device as a whole!

Plug connection

This device has one EN 175301-803 plug each for the power supply and the signal output. If the lead is connected correctly, these cannot be confused. Therefore please be sure to correctly reassemble the plugs after connecting the wires. Below you will find the pin assignments, with the numbers corresponding to those on the plugs:

The supply line cross-sections must be suitable for the rated current. Use a maximum line cross-section of 1.5 mm² (AWG 16) and a cable diameter of 8 - 10 mm (0.31 - 0.39 inch).

Pin assignment

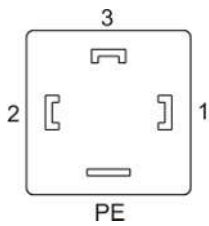

Power supply S1
115/230 V

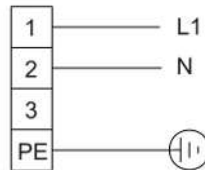

Alarm contact S2

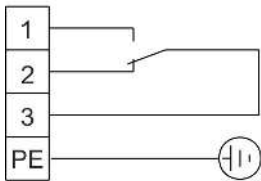

The clamping area has a diameter of 8-10 mm (0.31-0.39 in).

4.4 Signal Output

The device has a status signal (also see table "Signal Output Description"). The maximum switching power of the alarm outputs is 250 VAC/150 VDC, 2 A, 50 VA, each.

The alarm contact/status output (S2) will trigger an alarm if the cooler temperature is outside the set limits. It does not indicate if the alarm was triggered due to high or low temperature.

The front film has three LEDs:

Colour	Marking	Function
Red	S2	High/low temperature, device error
Yellow	S1	---
Green	OP	Normal operation

The LEDs OP and S2 indicate the device status similar to alarm contact S2.

Signal Output Description

	Function / contact type	Description
Regarding S2)	internal changeover contact: max. 250 VAC/150 VDC, 2 A, 50 VA	the following device statuses can be indicated via two switching outputs: Contact between 3 and 2 closed (alarm) – No mains voltage and/or actual temperature outside the alarm thresholds Contact between 3 and 1 closed (ok) – Mains voltage attached + actual temperature within the alarm thresholds

4.5 Testing Electric Strength

The controller electronics of the unit have a number of EMC safeguards. Testing the electric strength damages electronic filter components. The necessary tests of all assemblies required to be tested were carried out at the factory (test voltage ≥ 1.5 kV AC).

When retesting the electric strength yourself, disconnect the earth conductor from the controller electronics during the test and short-circuit L and N.

5 Operation and control

NOTICE



The device must not be operated beyond its specifications.

After switching on the cooler the block temperature will be displayed. The display will flash until the block temperature has reached the preset target value (\pm adjustable alarm range). The status contact is in the Alarm position.

Once the target temperature range has been reached, the temperature will continuously be displayed and the status contact switches over.

If the display flashes during operation or an error message appears, please refer to bullet "Troubleshooting".

Please refer to the data sheet for performance data and maximum ratings.

5.1 Description of functions

The cooler is controlled by a microprocessor. With the factory preset the control already incorporates the various characteristics of the built-in heat exchangers.

The programmable display shows the block temperature in the selected display unit ($^{\circ}\text{C}$ / $^{\circ}\text{F}$) (factory preset $^{\circ}\text{C}$). Application-specific settings can easily be configured guided by the menu, using the 5 buttons. For one, this applies to the target outlet dew point, which can be set from 3 to 20 $^{\circ}\text{C}$ (factory preset 5 $^{\circ}\text{C}$).

And then the warning thresholds can be adjusted for low and excess temperature. These are set relative to the outlet dew point τ_a setting.

For the low temperature the range is $\tau_a - 1$ to $- 3$ K (however minimum cooling block temperature 1 $^{\circ}\text{C}$), and the range for the high temperature is $\tau_a + 1$ to $+ 7$ K. The factory setting for both is 3 K.

The flashing display and the status relays indicate the conditions are below or above the configured warning range (e.g. after switching on).

The separated condensate can be drained via connected peristaltic pumps or add-on automatic condensate drains.

Fine mesh filters can also be used, which in turn can be installed in optional moisture detectors.

The glass dome allows the dirt level of the filter element to easily be determined.

5.2 Use of menu functions

Brief description of the operating principle:

The unit is operated using 5 keys. Their functions are:

Button	Section	Functions
← or OK	Display	– Switches from the measurement display to the main menu
	Menu	– Selects the menu item displayed
	Enter	– Applies an edited value or a selection
▲	Display	– temporarily switches to the alternative measurement display (if option installed)
	Menu	– Back
	Enter	– Increase value or browse selection – Note: – Press button 1 x = changes parameter / value by one; – Hold button = fast mode (numerical values only) – Display flashes: modified parameter/value – Steady display: original display/value
▼	Display	– temporarily switches to the alternative measurement display (if option installed)
	Menu	– Next
	Enter	– Reduce value or browse selection
ESC	Menu	– Move one level up
	Enter	– Return to menu Changes will not be saved!
F or Func		– Sets a menu to favourite. (Note: The favourite menu will also be activated with the menu locked!)

5.2.1 Lock Menu

Some menus can be locked to prevent inadvertently changing the settings of the unit. This requires setting a code. For information on setting up or disabling the menu lock please refer to "Global Settings" (*tOP*) under menu item *tOP* > *Loc*.

The menu lock is **not** enabled at the time of delivery, all menu items can be accessed.

With the menu locked, only the following menu items will be visible without entering the correct code:

Menu item	Explanation
<i>tOP</i> > <i>uni</i> <i>t</i>	Temperature unit selection (°C or °F).
F or Func.	Accessing the Favourites menu NOTICE! This menu may be one that is normally locked.

5.2.2 Menu navigation overview

When pressing the **OK** button in normal mode, the display will show the prompt `codE` if the menu is locked. Use the **▲** and **▼** buttons to enter the correct code and press **OK**.

If an incorrect code or no code is entered, the menu will not be unlocked and you will not be able to access all menu items.

If you forgot the password you can always enter master code 287 to access the menu; the menu will be unlocked.

The following image shows an overview of the menu structure.

Items with a dashed frame will only appear with the respective settings or with the respective status messages.

The factory settings and ranges are specified in the overview as well as under the respective menu item. The factory settings apply unless otherwise agreed.

You can cancel entries and menu selections without saving by pressing the **ESC** key.

Menu:

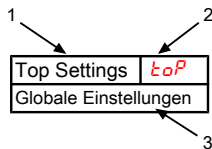

1. Menu designation
2. Display
3. Brief description

Parameter:

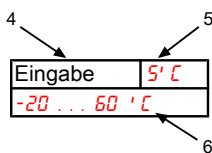

4. Value input
5. Factory preset
6. Parameter range

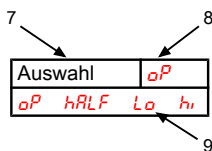

7. Selecting from the list of values
8. Factory preset
9. Parameter range/selection

Optional menu navigation:

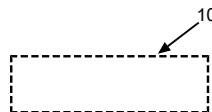

10. dashed box = Optional

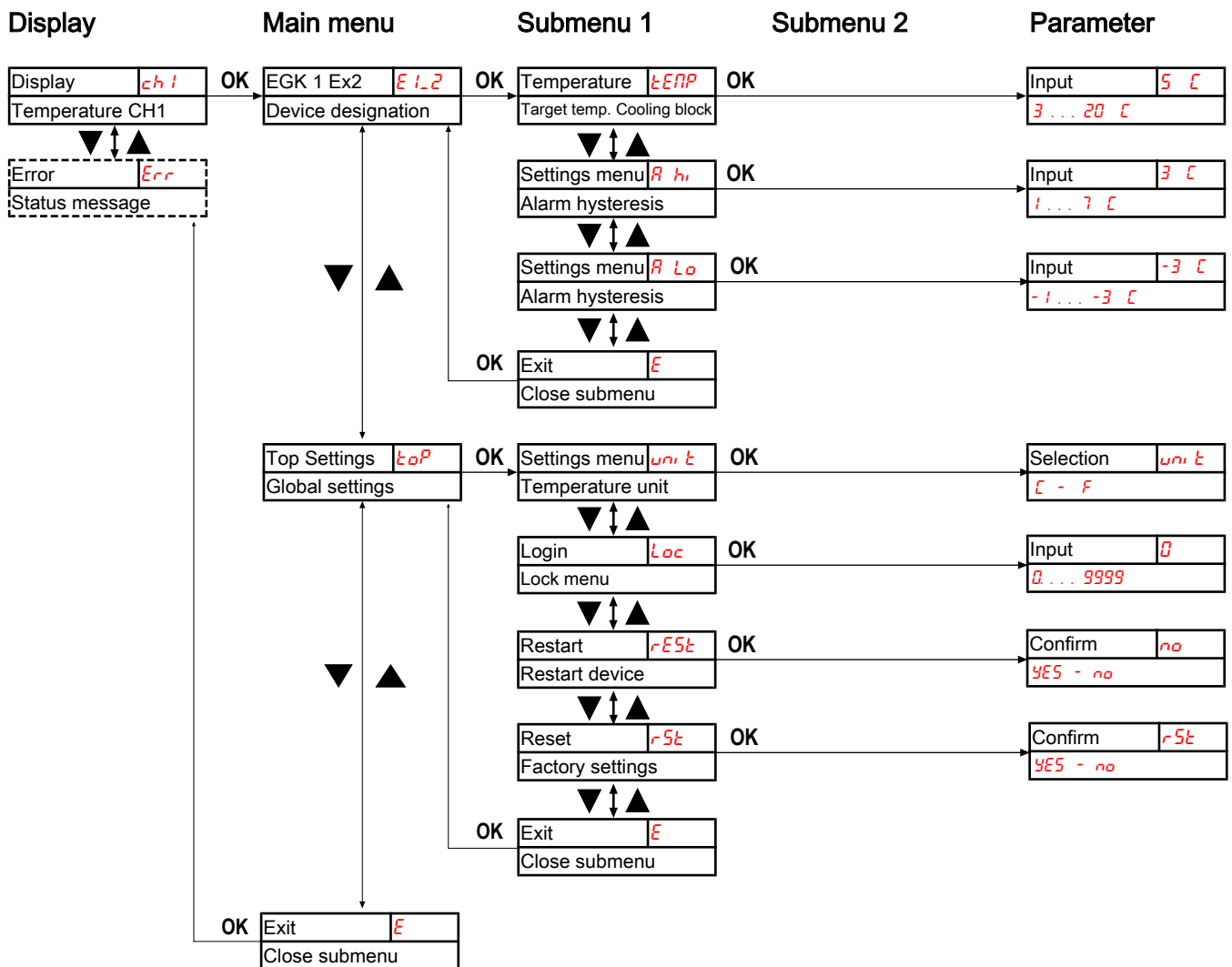

Fig. 1: EGK 1 Ex2 Menu Overview

5.3 Description of menu functions

5.3.1 Main menu

Cooler EGK 1 Ex2

Display → E1.2

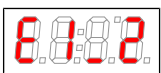

This will take you to the cooler target temperature and tolerance range setting (alarm threshold).

Global setting

Display → E0P (ToP Settings)

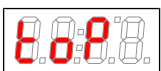

This menu is used to configure the global cooler settings.

Exit main menu

Display → E



Selecting this will return you to display mode.

5.3.2 Submenu 1

Target temperature

Display → Cooler → *TEMP*



This setting determines the nominal temperature for the cooler temperature.

Parameter range: 3 °C to 20 °C (37.4 °F to 68 °F)

Factory setting: 5 °C (41 °F)

Note: If the temperature is changed the indicator may blink, until the new operating range has been reached.

This menu item is hidden if the keylock is enabled.

upper alarm limit

Display → Cooler → *A hi* (Alarm high)

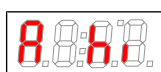

Here you can set the upper threshold for the visual signal and the alarm relay. The alarm limit is set based on the cooler temperature setting.

Parameter range: 1 °C to 7 °C (1.8 °F to 12.6 °F)

Factory setting: 3 °C (5.4 °F)

Note: This menu item is hidden if the keylock is enabled.

lower alarm limit

Display → Cooler → *A Lo* (Alarm low)

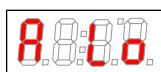

Here you can set the lower threshold for the visual signal and the alarm relay. The alarm limit is set based on the cooler temperature setting.

Parameter range: -1 °C to -3 °C (-1.8 °F to -5.4 °F)

Factory setting: -3 °C (-5.4 °F)

Note: This menu item is hidden if the keylock is enabled.

Exit submenu 1

Display → Submenu → *E*



Selecting this will return you to the main menu.

5.3.3 Submenu 1 (global settings)

Temperature unit

Display → *LoP* → *unit*



Used to select the temperature display unit.

Parameter range: *C, F*

Factory setting: *C*

Lock Menu

To protect the menu from unauthorised use, enter a value for the lock code. Menu items can then only be accessed after entering the correct code.

Display → *LoP* → *Loc*

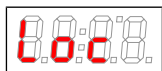

This setting will cancel/enable the menu lock.

Parameter range: 0 to 9999

Factory setting: 0 (keylock cancelled)

Note: This menu will be hidden if the menu is locked.

Restart

Display → *LoP* → *rESt*

(*rESt* = restart)



The device will restart, all settings are saved. All error messages will be reset. The moisture detector will be reset, irrespective of the settings in menus *h1 Ec* and *h101*.

Parameter range: *YES*: Restart. The display will show the software version for the device and returns to measurement display.

no: Exit menu without restarting.

Note: The user settings will be saved.

Factory settings

Display → *LoP* → *rSt*



This setting restores the factory settings.

Parameter range: *YES*: factory settings restored.

no: Exit menu without making changes.

Factory setting: *no*

Note: This menu will be hidden if the menu is locked.

Exit submenu 1

Display → Submenu → *E*



Selecting this will return you to the main menu.

5.3.4 Set favourite menu

Use the **F** or **Func** (function) key to set a favourite menu to later open it with just the push of a button.

- Open the menu you wish to set as the favourite. This menu can also be a lockable menu.
- Press the function key for more than 3 sec.
The current menu has been set as the favourite. The display will briefly show the message *Func*.
- Press **ESC** or *E* (Exit) to return to the display.

To now access the favourite menu, press the **F** or **Func** key.

NOTICE! The favourite menu can also be accessed if the menu is locked.

6 Maintenance

The basic version of the cooler requires no special maintenance.

However, it may have different options depending on the cooler model. In this case the following routine maintenance is required:

- **Optional peristaltic pump:** Check hoses
- **Filter option:** Check filter element

During maintenance, remember:

- The equipment must be maintained by a professional familiar with the safety requirements and risks.
- Only perform maintenance work described in these operating and installation instructions.
- Observe the respective safety regulations and operating specifications when performing any type of maintenance.
- Always use genuine spare parts.
- Only perform maintenance and cleaning when there is no explosive atmosphere or outside the explosive area.

DANGER

Electrical voltage

Electrocution hazard.



- a) Disconnect the device from power supply.
- b) Make sure that the equipment cannot be reconnected to mains unintentionally.
- c) The device must be opened by trained staff only.
- d) Regard correct mains voltage.



DANGER

Toxic, corrosive gas/condensate

Sample gas/condensate may be hazardous to health.



- a) If necessary, ensure a safe gas/condensate discharge.
- b) Always disconnect the gas supply when performing maintenance or repairs.
- c) Protect yourself from toxic/corrosive gasses/condensate when performing maintenance. Wear appropriate protective equipment.



7 Service and repair

This chapter contains information on troubleshooting and correction should an error occur during operation.

Repairs to the unit must be performed by Bühler authorised personnel.

Please contact our Service Department with any questions:

Tel.: +49-(0)2102-498955 or your agent

For further information about our services and customised maintenance visit <http://www.buehler-technologies.com/service>.

If the equipment is not functioning properly after correcting any malfunctions and switching on the power, it must be inspected by the manufacturer. Please send the equipment inside suitable packaging to:

Bühler Technologies GmbH

- Reparatur/Service -

Harkortstraße 29

40880 Ratingen

Germany

Please also attach the completed and signed RMA decontamination statement to the packaging. We will otherwise be unable to process your repair order.

You will find the form in the appendix of these instructions, or simply request it by e-mail:

service@buehler-technologies.com.

7.1 Troubleshooting







Problem / Malfunction	Possible cause	Action
Condensate inside the gas output	– Condensate trap full	– Empty condensate trap
	– Valve inside the automatic condensate drain may be stuck	– Flush in both directions
	– Cooler overload	– Maintain limits
Reduced gas flow rate	– Gas circuit clogged	– Remove and clean heat exchanger – if necessary, replace filter element
	– Condensate output iced over	– Send in unit
Excess temperature	– Operating point not yet reached	– Wait (max. 20 min)
	– Cooling output too low despite the cooler running	– Ensure the vents are not covered (heat buildup)
	– Flow rate too high/dew point too high/gas temperature too high	– Maintain limits / install pre-separator
	– Built-in fan stopped	– Check and replace if necessary
Temperature low	– Control unit failure	– Send in cooler
No cooling	– Compressor doesn't start up	– Compressor PTC not cooled down sufficiently. Wait 5 minutes and try again.
Fuse is triggering	– Increased compressor current consumption due to faulty compressor start-up	– Compressor PTC not cooled down sufficiently. Wait 5 minutes and try again.

7.1.1 Error messages on the display

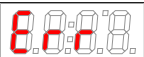
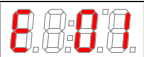
If an error occurs, the display will read "Err". Press the "▲" button to show the error number(s).

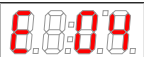
Error messages will appear until the unit has been restarted or the error is cleared using the "Func" button. It can only be cleared if the cause for the error has been corrected.

Causes / Action: The following is a list of the most common causes and actions for the respective error. If the actions listed do not resolve the problem, please contact Service.

Problem / Malfunction	Possible cause	Action
No display	<ul style="list-style-type: none"> – No voltage – Loose connecting cable – Display defective 	<ul style="list-style-type: none"> – Check the supply cable – Check fuse – Check connections
 D1.02 (permanent)	(The software version for the display will appear).	<ul style="list-style-type: none"> – Check connections
 Error	<ul style="list-style-type: none"> – Not communicating with the controller – An error has occurred 	<ul style="list-style-type: none"> – Read the error number as described above
 Error 01	<ul style="list-style-type: none"> – Controller malfunction 	<ul style="list-style-type: none"> – Clear error (temporary fault) – Disconnect from power for approx. 5 s – Contact service
 Error 03	<ul style="list-style-type: none"> – Microcontroller fault / MCP2 	<ul style="list-style-type: none"> – Contact service
 Error 04	<ul style="list-style-type: none"> – EEPROM error 	<ul style="list-style-type: none"> – Contact service
 Error 40	<ul style="list-style-type: none"> – General error temperature sensor 1 	<ul style="list-style-type: none"> – Sensor possibly defective
 Error 41	<ul style="list-style-type: none"> – Low temperature / short-circuit temperature sensor 1 	<ul style="list-style-type: none"> – Check temperature sensor connection
 Error 42	<ul style="list-style-type: none"> – Excess temperature / short-circuit temperature sensor 1 	<ul style="list-style-type: none"> – Check temperature sensor connection
 Error 43	<ul style="list-style-type: none"> – Measurement fluctuation temperature sensor 1 	<ul style="list-style-type: none"> – Check temperature sensor connection

7.2 Safety instructions

- The device must be operated within its specifications.
- All repairs must be carried out by Bühler authorised personnel only.
- Only perform modifications, servicing or mounting described in this manual.
- Only use original spare parts.

DANGER

Electrical voltage

Electrocution hazard.

- Disconnect the device from power supply.
- Make sure that the equipment cannot be reconnected to mains unintentionally.
- The device must be opened by trained staff only.
- Regard correct mains voltage.



DANGER**Toxic, corrosive gas/condensate**

Sample gas/condensate may be hazardous to health.

- a) If necessary, ensure a safe gas/condensate discharge.
- b) Always disconnect the gas supply when performing maintenance or repairs.
- c) Protect yourself from toxic/corrosive gasses/condensate when performing maintenance. Wear appropriate protective equipment.

**CAUTION****Health hazard in case of leaking cooling circuit / heat exchanger**

The cooling circuit is filled with coolant R134a.

The heat exchanger is filled with a coolant based on glycol.

In case of leaking / broken cooling circuit / heat exchanger:

- a) Avoid contact with skin or eyes.
- b) Do not ingest or inhale coolant.
 - ⇒ Due to the small amount of coolant no health hazards need be feared.
 - ⇒ Do not put the device back to operation if leakage of the cooling circuit happend.

DANGER**Spark formation due to electrostatic charge**

Always clean plastic housing parts and decals with a damp cloth.

Connect metal housings with earth potential (PE) conductive!

7.3 Cleaning and removal of the heat exchanger

Heat exchangers only need to be replaced or maintained if clogged or damaged. If they are clogged, we recommend checking if using a filter will avoid future occurrences.

- Close gas supply.
- Switch off device and disconnect all plugs (e.g. status output connector, supply input, etc.).
- Disconnect gas connections and condensate drain.
- Pull the heat exchanger up and out.
- Clean cleaning nest (hole inside the cooler block), as the heat exchangers are installed with silicone grease.
- Flush the heat exchanger until all contaminants have been removed.
- Grease the cooled outside surface external surface with silicone grease.
- Reinsert the heat exchanger into the cooling nest with a rotating movement.
- Reconnect the gas supply and condensate drain. The gas inlet is marked red.
- Restore power/gas supply and wait for unit to be ready for operation.
- Open gas supply.

7.4 Replacing the hoses of the peristaltic pump (option)

- Turn off gas supply.
- Switch the device off and disconnect power supply.
- Remove the supplying and draining hoses from the pump (**Take care of the safety instructions!**).
- Loosen the centre knurled screw but do not remove it. Push the screw downwards.
- Pull off the cover.
- Pull the connections sideways and remove the hose.
- Replace the hose and remount the pump in reverse order.
- Reconnect power supply.

7.5 Spare Parts

Please also specify the model and serial number when ordering parts.

Upgrade and expansion parts can be found in our catalog.

Available spare parts:

Item no.	Description
9100100007	Display module MCD 400
456300001	Controller board MCP 2
4510150	One peristaltic pump CPsingle X2 with auxiliary angle, 115/230 VAC 50/60 Hz, 90° nipple
4510250	Two peristaltic pumps CPsingle X2 with auxiliary angle, 115/230 VAC 50/60 Hz, 90° nipple
4510151	One peristaltic pump CPsingle X2 with auxiliary angle, 115/230 VAC 50/60 Hz, metric screw connection
4510251	Two peristaltic pumps CPsingle X2 with auxiliary angle, 115/230 VAC 50/60 Hz, metric screw connection
4510152	One peristaltic pump CPsingle X2 with auxiliary angle, 115/230 VAC 50/60 Hz, US screw connection
4510252	Two peristaltic pumps CPsingle X2 with auxiliary angle, 115/230 VAC 50/60 Hz, US screw connection
9124040023	Fan 230 V
9124040026	Fan 115 V
9100010220	Mains and controller board 230 V
9100011220	Mains and controller board 115 V
456300002	Mains cable incl. decal *
456300003	Alarm output cable incl. decal *

* for EAC Ex version.

7.5.1 Consumables and accessories

Item no.	Description
4410 001	Automatic condensate drain 11 LD V 38
4410004	Automatic condensate drain AK 20, PVDF *
4410005	Condensate trap GL 1; glass, 0.4 L *
4410019	Condensate trap GL 2; glass, 1 L *
44920035011	Condensate pump hose, Tygon (Norprene), straight hose nipple
44920035012	Condensate pump hose, Tygon (Norprene), angled hose nipple
44920035013	Condensate pump hose, Tygon (Norprene), straight and angled hose nipple
44920035016	Condensate pump hose, Tygon (Norprene), angled hose nipple and screw connection (metric)
44920035017	Condensate pump hose, Tygon (Norprene), angled hose nipple and screw connection (US)
44921222102	Peristaltic pump CPsingle-OEM-AC X2 with angled hose nipple
44921222104	Peristaltic pump CPsingle-OEM-AC X2 with screw-in hose connection (metric)
44921222105	Peristaltic pump CPsingle-OEM-AC X2 with screw-in hose connection (US)

*approved for non-flammable and flammable gases explosion class IIB.

8 Disposal

The refrigerant circuit of the cooler contains R134a refrigerant. The heat exchanger is charged with glycol-based coolant.

The applicable national laws must be observed when disposing of the products. Disposal must not result in a danger to health and environment.

The crossed out wheelee bin symbol on Bühler Technologies GmbH electrical and electronic products indicates special disposal notices within the European Union (EU).



The crossed out wheelee bin symbol indicates the electric and electronic products bearing the symbol must be disposed of separate from household waste. They must be properly disposed of as waste electrical and electronic equipment.

Bühler Technologies GmbH will gladly dispose of your device bearing this mark. Please send your device to the address below for this purpose.



We are obligated by law to protect our employees from hazards posed by contaminated devices. Therefore please understand that we can only dispose of your waste equipment if the device is free from any aggressive, corrosive or other operating fluids dangerous to health or environment. **Please complete the "RMA Form and Decontamination Statement", available on our website, for every waste electrical and electronic equipment. The form must be applied to the packaging so it is visible from the outside.**

Please return waste electrical and electronic equipment to the following address:

Bühler Technologies GmbH
WEEE
Harkortstr. 29
40880 Ratingen
Germany

Please also observe data protection regulations and remember you are personally responsible for the returned waste equipment not bearing any personal data. Therefore please be sure to delete your personal data before returning your waste equipment.

9 Appendices

9.1 Gas cooler technical data

Gas Cooler Technical Data

Ready for operation:	after max. 15 minutes		
Rated cooling capacity (at 25 °C):	320 kJ/h		
Ambient temperature:	5 °C to 50 °C		
Gas output dew point			
preset:	approx. 5 °C		
adjustable:	3 °C to 20 °C		
Dew point fluctuations			
static:	± 0.1 K		
in the entire specification range:	± 1.5 K		
IP rating:	IP 20		
Housing:	Stainless steel		
Packaging dimensions:	approx. 390 x 300 x 400 mm		
Weight incl. heat exchanger:	approx. 15 kg		
Electric supply:	115 V, 60 Hz or 230 V, 50 Hz Plug per DIN EN 175301-803 EAC Ex version incl. mains and alarm cable		
Electrical data:	230 V	115 V	
	Typical power input:	140 VA	155 VA
	max. operating current:	1.6 A	3.2 A
	temporary starting currents are significantly higher.		
Alarm output switching connection:	max. 250 V, 2 A, 50 VA Terminal plug per DIN EN 175301-803		
Installation:	stand-alone or wall-mounted, dry and dust-free		
Markings:	ATEX:  II 3G Ex ec nA nC IIC T4 Gc IECEX: Ex ec nA nC IIC T4 Gc EAC Ex: 2Ex e nA nC IIC T4		
Applied standards:	IEC 60079-0 (Ed. 6.0); IEC 60079-7 (Ed. 5.0); IEC 60079-15 (Ed. 4.0) EN 60079-0:2012+A11:2013; EN 60079-7:2015; EN 60079-15:2010		
IECEX certificate number:	IECEX IBE 17.0023X		
EAC Ex certificate number:	TC RU C-DE.MIO62.B.05995		

9.2 Technical Data - Options

CPsingle Peristaltic Pumps Technical Data

Flow rate	0.3 L/h (50 Hz) / 0.36 L/h (60 Hz) with standard hose
Vacuum inlet	max. 0.8 bar
Pressure inlet	max. 1 bar
Outlet pressure	1 bar
Hose	4 x 1.6 mm
Protection class	IP 40
Materials	
Hose:	Norprene (standard), Marprene, Fluran
Connections:	PVDF

9.3 Performance data

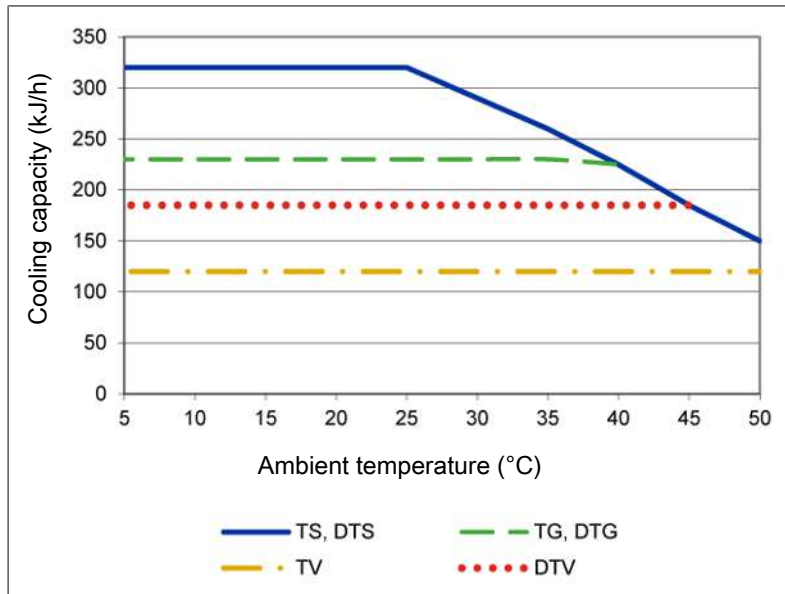

Remark: The limit curves for the heat exchangers exchanger apply to a dew point of 65 °C.

9.4 Diagram typical installation

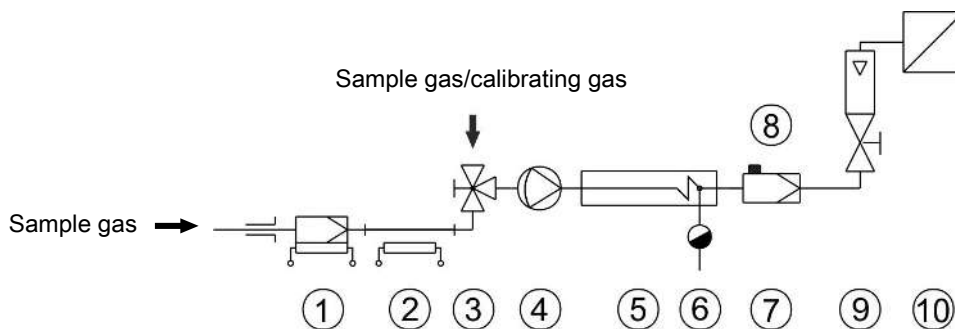

1 Sample gas probe	2 Sample gas line
3 Reversing tap	4 Sample gas pump
5 Sample gas cooler	6 Automatic condensate drain or peristaltic pump
7 Fine mesh filter	8 Moisture detector
9 Flow meter	10 Analyser

See data sheets for individual component models and data.

9.5 Heat exchanger

9.5.1 Heat exchanger description

The energy content of the sample gas and the required cooling capacity of the gas cooler is determined by three parameters: gas temperature ϑ_G , (inlet) dew point τ_e (moisture content) and volume flow v . The outlet dew point rises with increasing energy content of the gas. The approved energy load from the gas is therefore determined by the tolerated rise in the dew point.

The following limits are specified for a normal standard operating point of $\tau_e = 65$ °C and $\vartheta_G = 90$ °C. The maximum volume flow v_{max} in NI/h of cooled air is indicated, so after moisture has condensed.

If the values fall below τ_e and ϑ_G , the flow v_{max} may be increased. For example, on the TG heat exchanger the parameter triple $\tau_e = 65$ °C, $\vartheta_G = 90$ °C and $v = 280$ NI/h may also be used in place of $\tau_e = 50$ °C, $\vartheta_G = 80$ °C and $v = 380$ NI/h

Please contact our experts for clarification or refer to our design program.

9.5.2 Heat exchanger overview

Heat exchanger	TS TS-I ²⁾	TG TG	TV TV-I ²⁾	DTS (DTS-6 ³⁾) DTS-I (DTS-6-I ³⁾) ²⁾	DTG DTG	DTV ³⁾ DTV-I ²⁾³⁾
Materials in contact with media	Stainless steel	Glass PTFE	PVDF	Stainless steel	Glass PTFE	PVDF
Flow rate v_{\max} ¹⁾	530 L/h	280 L/h	155 L/h	2 x 250 L/h	2 x 140 L/h	2 x 115 L/h
Inlet dew point $\tau_{e,\max}$ ¹⁾	80 °C	80 °C	65 °C	80 °C	65 °C	65 °C
Gas inlet temperature $\vartheta_{G,\max}$	130 °C (180 °C) ⁵⁾	130 °C	130 °C	130 °C (180 °C) ⁵⁾	130 °C	130 °C
Max. cooling capacity Q_{\max}	450 kJ/h	230 kJ/h	120 kJ/h	450 kJ/h	230 kJ/h	185 kJ/h
Gas pressure p_{\max}	160 bar	3 bar	3 bar	25 bar	3 bar	2 bar
Pressure drop Δp ($v=150$ L/h)	8 mbar	8 mbar	8 mbar	5 mbar each	5 mbar each	15 mbar each
Dead volume V_{dead}	69 ml	48 ml	129 ml	28/25 ml	28/25 ml	21/21 ml
Gas connections (metric)	G1/4	GL 14 (6 mm) ⁴⁾	DN 4/6	6 mm tube	GL14 (6 mm) ⁴⁾	DN 4/6
Gas connections (US)	NPT 1/4"	GL 14 (1/4") ⁴⁾	1/4"-1/6"	1/4" tube	GL14 (1/4") ⁴⁾	1/4"-1/6"
Condensate out connections (metric)	G3/8	GL 25 (12 mm) ⁴⁾	G3/8	Tube 10 mm (6 mm)	GL18 (10 mm) ⁴⁾	DN 5/8
Condensate out connections (US)	NPT 3/8"	GL 25 (1/2") ⁴⁾	NPT 3/8"	Tube 3/8" (1/4")	GL18 (3/8") ⁴⁾	3/16"-5/16"

¹⁾ Considering the maximum cooling capacity of the cooler.

²⁾ Models marked I have NPT threads or US tubes, respectively.

³⁾ Condensate drain only possible with condensate pump.

⁴⁾ Gasket inside diameter.

⁵⁾ With temperature class T3 gases the permissible gas inlet temperature is max. 180 °C.

9.6 Dimensions (mm)

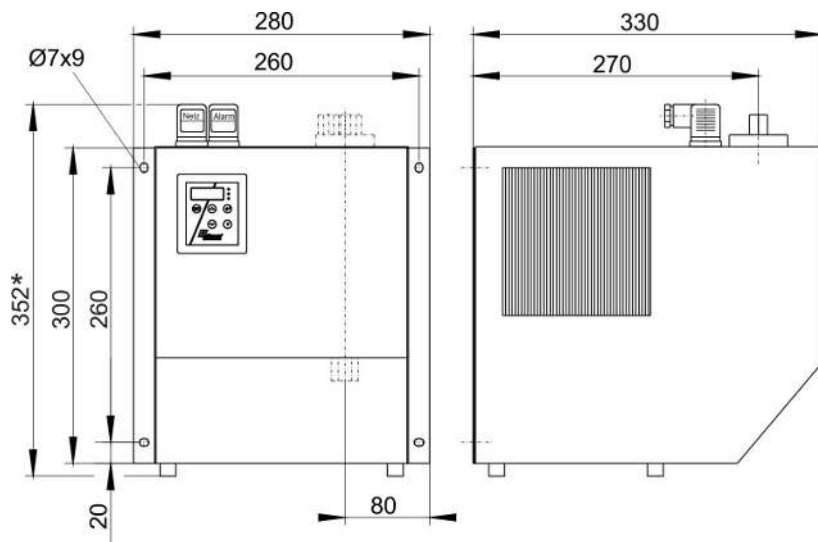

* on EAC Ex unit 359 mm through connection cable.

10 Attached documents

- Type Examination Certificate
- IECEX Certificate
- EAC Ex certificate
- Declaration of Conformity KX450018
- RMA - Decontamination Statement

IBExU Institut für Sicherheitstechnik GmbH
An-Institut der TU Bergakademie Freiberg



- [1] **TYPE EXAMINATION CERTIFICATE - Translation**
- [2] Equipment
of equipment-groups I and II, equipment-categories M2 and 2 plus 3
- [3] Type examination certificate number **IBExU17ATEXB006 X** | Issue 0
- [4] Product: **sample gas chiller**
Type: EGK 1 Ex2
- [5] Manufacturer: Bühler Technologies GmbH
- [6] Address: Harkortstr. 29
40880 Ratingen
GERMANY
- [7] This product and any acceptable variation thereto is specified in the schedule to this certificate and the documents therein referred to.
- [8] IBExU Institut für Sicherheitstechnik GmbH certifies that this product has been found to comply with the essential health and safety requirements relating to the design and construction of products intended for use in potentially explosive atmospheres given in Annex II to Directive 2014/34/EU of the European Parliament and of the Council, dated 26 February 2014.
- The examination and test results are recorded in the confidential test report IB-16-3-148.
- [9] Compliance with the essential health and safety requirements has been assured by compliance with:
EN 60079-0:2012 + A11:2013 EN 60079-7:2015 EN 60079-15:2010
except in respect of those requirements listed at item [18] of the schedule.
- [10] If the sign "X" is placed after the certificate number, it indicates that the product is subject to the specific conditions of use specified in the schedule to this certificate.
- [11] This type examination certificate relates only to the design of the specified equipment and not to specific items of equipment subsequently manufactured or supplied.
- [12] The marking of the product shall include the following:

⊕ II 3G Ex ec nA nC IIC T4 Gc

IBExU Institut für Sicherheitstechnik GmbH
Fuchsmühlenweg 7
09599 Freiberg, GERMANY

Tel: + 49 (0) 37 31 / 38 05 0
Fax: + 49 (0) 37 31 / 38 05 10

By order

Dipl.-Ing. [FH] A. Henker

IBExU
Institut für Sicherheitstechnik GmbH
Fuchsmühlenweg 7
09599 Freiberg/Sachsen
Telefon (03731) 3805-0
Telefax (03731) 38 05 10

- Stamp -

Certificates without signature and stamp are not valid. Certificates may only be duplicated completely and unchanged. In case of dispute, the German text shall prevail.

Freiberg, 2018-03-07

[13] **Schedule**

[14] **Certificate number IBExU17ATEXB006 X | Issue 0**

[15] **Description of product**

Sample gases contain vapour which has to be withdrawn before it reaches the gas analyzer. The Gas flows through a heat exchanger (impinger) inserted into a cooling block. The latter then is cooled to a preset temperature (5 °C mostly).

Electrical Data:

rated voltage:	230 V	115 V
rated power:	140 VA	155 VA
max. current:	1.6 A	3.2 A

[16] **Test report**

The test results are recorded in the confidential test report IB-16-3-148 of 2018-03-07.

The test documents are part of the test report and they are listed there.

Summary of the test results

The sample gas chiller type EGK 1 Ex2 complies with the requirements of the ignition protection type "increased safety "e" in combination with ignition protection type "n" for an explosion-proof device for group II and category 3 G.

[17] **Specific conditions of use**

The sample gas chiller must be installed in a casing suitable for EPL Gc.

The permissible ambient temperature of +5 °C up to +50 °C must be maintained.

Enough space before the ventilation holes has to be provided.

Adequate ventilation has to be ensured.

[18] **Essential health and safety requirements**

In addition to the essential health and safety requirements (EHSRs) covered by the standards listed at item [9], the following are considered relevant to this product, and conformity is demonstrated in the test report: none

[19] **Drawings and Documents**

The documents are listed in the test report.

IBExU Institut für Sicherheitstechnik GmbH
Fuchsmühlenweg 7
09599 Freiberg, GERMANY

By order



Dipl.-Ing. [FH] A. Henker

Freiberg, 2018-03-07



IECEX Certificate of Conformity

INTERNATIONAL ELECTROTECHNICAL COMMISSION IEC Certification Scheme for Explosive Atmospheres

for rules and details of the IECEx Scheme visit www.iecex.com

Certificate No.: IECEx IBE 17.0023X

Issue No: 0

Certificate history:

Issue No. 0 (2018-03-02)

Status: **Current**

Page 1 of 3

Date of Issue: **2018-03-02**

Applicant: **Bühler Technologies GmbH**
Harkortstr. 29
40880 Ratingen
Germany

Equipment: **sample gas chiller EGK 1 Ex2**

Optional accessory:

Type of Protection: **increased safety "e" in combination with type of protection "n"**

Marking:

Ex ec nA nC IIC T4 Gc

Approved for issue on behalf of the IECEx
Certification Body:

Dipl.-Ing. Alexander Henker

Position:

Deputy Head of Certification Body

Signature:
(for printed version)

Date:

2018-03-02

1. This certificate and schedule may only be reproduced in full.
2. This certificate is not transferable and remains the property of the issuing body.
3. The Status and authenticity of this certificate may be verified by visiting the Official IECEx Website.

Certificate issued by:

IBExU Institut für Sicherheitstechnik GmbH
Certification Body
Fuchsmühlenweg 7
09599 Freiberg
Germany



IECEX Certificate of Conformity

Certificate No: IECEX IBE 17.0023X Issue No: 0
Date of Issue: 2018-03-02 Page 2 of 3
Manufacturer: **Bühler Technologies GmbH**
Harkortstr. 29
40880 Ratingen
Germany

Additional Manufacturing location(s):

This certificate is issued as verification that a sample(s), representative of production, was assessed and tested and found to comply with the IEC Standard list below and that the manufacturer's quality system, relating to the Ex products covered by this certificate, was assessed and found to comply with the IECEx Quality system requirements. This certificate is granted subject to the conditions as set out in IECEx Scheme Rules, IECEx 02 and Operational Documents as amended.

STANDARDS:

The electrical apparatus and any acceptable variations to it specified in the schedule of this certificate and the identified documents, was found to comply with the following standards:

IEC 60079-0 : 2011 Explosive atmospheres - Part 0: General requirements
Edition:6.0
IEC 60079-15 : 2010 Explosive atmospheres - Part 15: Equipment protection by type of protection "n"
Edition:4
IEC 60079-7 : 2015 Explosive atmospheres – Part 7: Equipment protection by increased safety "e"
Edition:5.0

*This Certificate **does not** indicate compliance with electrical safety and performance requirements other than those expressly included in the Standards listed above.*

TEST & ASSESSMENT REPORTS:

A sample(s) of the equipment listed has successfully met the examination and test requirements as recorded in

Test Report:

DE/IBE/ExTR16.0032/00

Quality Assessment Report:

DE/BVS/QAR16.0002/01



IECEX Certificate of Conformity

Certificate No: IECEx IBE 17.0023X

Issue No: 0

Date of Issue: 2018-03-02

Page 3 of 3

Schedule

EQUIPMENT:

Equipment and systems covered by this certificate are as follows:

Sample gases contain vapour which has to be withdrawn before it reaches the gas analyzer. The Gas flows through a heat exchanger (impinger) inserted into a cooling block. The latter then is cooled to a preset temperature (5°C mostly). The gas is cooled or heated as required.

Electrical Data:

rated voltage: 230 V 115 V
rated power: 140 VA 155 VA
max. current: 1.6 A 3.2 A

SPECIFIC CONDITIONS OF USE: YES as shown below:

The sample gas chiller must be installed in a casing suitable for EPL Gc.

The permissible ambient temperature of +5 °C up to +50 °C must be maintained.

Enough space before the ventilation holes has to be provided.

Adequate ventilation has to be ensured.



СЕРТИФИКАТ СООТВЕТСТВИЯ

№ ТС RU C-DE.МЮ62.В.05995

Серия RU № 0338975

ОРГАН ПО СЕРТИФИКАЦИИ

продукции Общество с ограниченной ответственностью «ПРОММАШ ТЕСТ».
 Место нахождения: 117246, город Москва, Научный проезд, дом 8, строение 1, помещение XIX, комната №14-17.
 Адрес места осуществления деятельности: 115114, Российская Федерация, город Москва, Дербеневская набережная,
 дом 11, помещение 60. Телефон: +7 (495) 481-33-80, адрес электронной почты: info@prommashtest.ru. Аттестат
 аккредитации регистрационный № РОСС RU.0001.11МЮ62. Дата регистрации аттестата аккредитации 28.10.2013 года

ЗАЯВИТЕЛЬ

Общество с ограниченной ответственностью «ЛОГОСГРУП».
 Основной государственный регистрационный номер: 1167746131574.
 Место нахождения: 105264, Российская Федерация, город Москва, улица Парковая 10-я, дом 18, помещение 9, офис 24
 Телефон: 74991104221, адрес электронной почты: info@logosgrup.ru

ИЗГОТОВИТЕЛЬ

Buhler Technologies GmbH.
 Место нахождения: ГЕРМАНИЯ, DE-40880, Ratingen, Harkorstrasse, 29

ПРОДУКЦИЯ

Охладитель пробы, тип EGK 1 Ex2
 Маркировка взрывозащиты приведена в приложении (бланки №№ 0472774, 0472775).
 Оборудование изготовлено в соответствии с Директивой 2014/34/EU, для работы во взрывоопасных средах в
 соответствии с требованиями Технического регламента ТР ТС 012/2011.
 Серийный выпуск

КОД ТН ВЭД ТС 8419 00 000 0

СООТВЕТСТВУЕТ ТРЕБОВАНИЯМ

Технического регламента Таможенного союза ТР ТС 012/2011
 "О безопасности оборудования для работы во взрывоопасных средах"

СЕРТИФИКАТ ВЫДАН НА ОСНОВАНИИ

- акта о результатах анализа состояния производства Buhler Technologies GmbH от 27.06.2018 года;
 - протокола испытаний № 2116/ЗИЛПМ-2018 от 29.08.2018 года, выданного испытательным центром Общества с
 ограниченной ответственностью "ПРОММАШ ТЕСТ", аттестат аккредитации регистрационный номер RA.RU.21BC05.

Схема сертификации: Ic

ДОПОЛНИТЕЛЬНАЯ ИНФОРМАЦИЯ

Условия хранения - от минус 20 °С до плюс 60 °С. Срок хранения - не более 12 месяцев. Срок службы - не менее 5 лет.
 Стандарты, обеспечивающие соблюдение требований Технического регламента Таможенного союза ТР ТС 012/2011
 "О безопасности оборудования для работы во взрывоопасных средах": приведены в приложении (бланки №№ 0472774, 0472775).

СРОК ДЕЙСТВИЯ С 30.08.2018 ПО 29.08.2023 ВКЛЮЧИТЕЛЬНО

Руководитель (уполномоченное
 лицо) органа по сертификации

М.И.Родзивон
 (подпись)

Галина Александровна Родзивон
 (инициалы, фамилия)

Эксперт (эксперт-аудитор)
 (эксперты (эксперты-аудиторы))

Юрий Станиславович Любровский
 (подпись)

Юрий Станиславович Любровский
 (инициалы, фамилия)

ПРИЛОЖЕНИЕ

К СЕРТИФИКАТУ СООТВЕТСТВИЯ № ТС RU C-DE.МЮ62.В.05995

Серия RU № 0472774

1. Назначение и область применения

Сертификат соответствия распространяется на охладители пробы типа EGK 1 Ex2, выпускаемые серийно по технической документации изготовителя.

Охладитель пробы типа EGK 1 Ex2 предназначен для использования в системах анализа газа и является основным компонентом для подготовки анализируемого газа, он предназначен для защиты анализатора от остаточной влаги анализируемого газа.

Область применения – взрывоопасные зоны класса 2 помещений и наружных установок, в которых могут образовываться смеси, отнесенные к подгруппам IIА, IIВ и IIС, в соответствии с присвоенной маркировкой взрывозащиты 2Ex e nA nC IIС Т4, согласно требованиям ГОСТ IEC 60079-14-2011 и отраслевых Правил безопасности, регламентирующих применение данного электрооборудования во взрывоопасных зонах при температуре окружающего воздуха от +5°C до + 50°C.

2. Описание оборудования и средств обеспечения взрывозащиты

Конструктивно прибор представляет собой устройство прямоугольного сечения, предназначенное для монтажа внутри оболочки, имеющей защиту от внешних воздействий не менее IP54 и имеющей действующий сертификат ТР ТС 012/2011, позволяющий применять эту оболочку в зоне 2.

Внутри охладителя пробы типа EGK 1 Ex2 находится система охлаждения и осушения анализируемого газа, выполненные на основе сепаратора. Система охлаждения состоит из компрессора, обеспечивающего циркуляцию хладагента по замкнутому контуру, радиаторной решетки и вентилятора, отводящего тепло с радиатора и охлаждающего контура внутри сепаратора.

Система осушения выполнена на основе нагревательного элемента, после охлаждения до температуры близкой к «точке росы» из газа конденсирует остаточная влажность в виде жидкости, которая скапливается в нижней части сепаратора, а осушенный газ подогревается. Из сепаратора жидкость откачивается при помощи перистальтического насоса. На лицевой стороне прибора расположен жидко кристаллический дисплей.

Таблица 1. Основные технические данные охладители пробы типа EGK 1 Ex2.

Наименование показателя	Значение	
Напряжение питания, В	230	115
Переменного тока		
Постоянного тока	140	155
Электрическая мощность, В*А		
Максимальный ток, А	1.6	3.2
Степень защиты от внешних воздействий	IP54	
Температура окружающей среды, °С	от +5 до +50	
Маркировка взрывозащиты	2Ex e nA nC IIС Т4	

Взрывозащищенность оборудования обеспечивается выполнением его конструкции в соответствии с общими требованиями ГОСТ 31610.0-2012, а также видами взрывозащиты: «защита вида «е» по ГОСТ 31610.7-2012/ IEC 60079-7:2006 и «защита вида «п» по ГОСТ 31610.15-2012, в принятии мер, препятствующих образованию источника воспламенения, а именно:

- применением надежного электрического соединения устройств внутри оболочки, которые не приводят к нагреву проводников в месте контакта сверх температуры, регламентированной для температурного класса Т4;
- обеспечением электрических зазоров и расстояний утечки между токоведущими частями согласно требованиям стандартов ГОСТ 31610.7-2012 и ГОСТ 31610.15-2012;
- выполнением качественной изоляции, обеспечивающей отсутствием нагрева обмоток сверх температуры, регламентированной для температурного класса Т4, в случае остановки вентилятора;
- проверкой электрической прочности изоляции напряжением 1500 В;

Руководитель (уполномоченное
лицо) органа по сертификации

Эксперт-аудитор (эксперт)

Галина Александровна Родзиков
подпись

Галина Александровна Родзиков
инициалы, фамилия

Юрий Станиславович Любовский
подпись

Юрий Станиславович Любовский
инициалы, фамилия



ПРИЛОЖЕНИЕ

К СЕРТИФИКАТУ СООТВЕТСТВИЯ № ТС RU C-DE.MIO62.B.05995

Серия RU № 0472775

– наличием внутри и снаружи заземляющих зажимов, а также специальной заземляющей жилы кабеля;

– выполнением специальных условий применения при монтаже и эксплуатации;

монтаж, эксплуатация, ремонт и обслуживание электрооборудования, входящего в состав охладителя пробы типа EGK 1 Ex2, должны производиться в строгом соответствии с требованиями соответствующих руководств по эксплуатации. Обслуживающий персонал должен строго соблюдать требования к параметрам окружающей и рабочей сред, установленные в руководстве по эксплуатации.

3. Охладитель пробы типа EGK 1 Ex2 соответствует требованиям:

ТР ТС 012/2011

Технический регламент Таможенного союза «О безопасности оборудования для работы во взрывоопасных средах»;

ГОСТ 31610.0-2012 (IEC 60079-0:2004)

Электрооборудование для взрывоопасных газовых сред. Часть 0. Общие требования.

ГОСТ 31610.7-2012/ IEC 60079-7:2006

Электрооборудование для взрывоопасных газовых сред. Часть 7. Повышенная защита вида "е".

ГОСТ 31610.15-2012/IEC 60079-15:2005

Электрооборудование для взрывоопасных газовых сред. Часть 15. Конструкция, испытания и маркировка электрооборудования с видом защиты "n".

4. Маркировка

Маркировка, наносимая на электрооборудование, должна включать следующие данные:

- наименование предприятия-изготовителя или его зарегистрированный товарный знак;
- обозначение типа оборудования;
- порядковый номер по системе нумерации предприятия-изготовителя;
- маркировку взрывозащиты см. п. 2 «Основные технические данные»;
- наименование или знак органа по сертификации и номер сертификата соответствия;
- предупредительные надписи;
- единый знак ЕАС обращения продукции на рынке государств - членов Таможенного союза;
- специальный знак взрывобезопасности **Ex** в соответствии с ТР ТС 012/2011;
- Другие данные, которые должен отразить изготовитель, если это требуется технической документацией (диапазон температур окружающей среды, степень защиты оболочки и т.д.).

5. Специальные условия применения

- Образец газового холодильника должен быть установлен в оболочку, имеющую уровень взрывозащиты не ниже «повышенная надежность против взрыва» и подходящую для использования в зоне 2;
- Должна поддерживаться допустимая температура окружающей среды от +5 до +50 °С для предотвращения замерзания конденсата;
- При установке должно быть предусмотрено достаточно места перед вентиляционными отверстиями для обеспечения вентиляции;
- Должна быть обеспечена адекватная вентиляция.



Руководитель (уполномоченное лицо) органа по сертификации

Эксперт-аудитор (эксперт)

подпись

Галина Александровна Родзивон
инициалы, фамилия

подпись

Юрий Станиславович Любовский
инициалы, фамилия

EU-Konformitätserklärung
EU-declaration of conformity



Hiermit erklärt Bühler Technologies GmbH, dass die nachfolgenden Produkte den wesentlichen Anforderungen der Richtlinie

Herewith declares Bühler Technologies GmbH that the following products correspond to the essential requirements of Directive

2014/34/EU
(Atex)

in ihrer aktuellen Fassung entsprechen.

in its actual version.

Produkt / products: Messgaskühler / *Sample gas cooler*
Typ / type: EGK 1 Ex2

Die Produkte werden entsprechend der derzeit gültigen Atex-Richtlinie innerhalb der internen Fertigungskontrolle folgendermaßen gekennzeichnet:
The products are marked according to the currently valid Atex directive during internal control of production:

Atex:  II 3G Ex ec nA nC IIC T4 Gc
IECEX: Ex ec nA nC IIC T4 Gc

Die Eignung dieses Produkts für die Zone 2 wurde durch eine Baumusterprüfbescheinigung mit der Nummer IBExU17ATEXB006X festgestellt.

Die Betriebsanleitung zu diesem Produkt beinhaltet besondere Installations- und Betriebsbedingungen und sind für die sichere Anwendung zu beachten.

This product's suitability for Zone 2 was determined by type-examination certificate number IBExU17ATEXB006X.

The operating instructions for this product contains special installation and operating conditions and must be observed to ensure safe operation.

Zur Beurteilung der Konformität wurden folgende harmonisierte Normen herangezogen:
For the assessment of conformity the following standards have been used:

EN 60079-0:2012 + A11:2013

EN 60079-7:2015

EN 60079-15:2010

Zusätzlich wurden berücksichtigt:
In addition, the following standards have been used:

EN 13463-1:2009

EN 13463-1:2011

Der Hersteller hat die Übereinstimmung des Gerätes mit aktuelleren Normenausgaben als in der Baumusterprüfbescheinigung aufgeführt geprüft und die Konformität festgestellt:

The manufacturer has checked the compliance of the device with more current standards than those listed in the type examination certificate and has established conformity:

EN IEC 60079-0:2018

EN IEC 60079-7 + A1:2018

Dokumentationsverantwortlicher für diese Konformitätserklärung ist Herr Stefan Eschweiler mit Anschrift am Firmensitz.

The person authorised to compile the technical file is Mr. Stefan Eschweiler located at the company's address.

Ratingen, den 15.04.2021

Stefan Eschweiler
Geschäftsführer – *Managing Director*

Frank Pospiech
Geschäftsführer – *Managing Director*

KX 45 0018

Bühler Technologies GmbH, Harkortstr. 29, D-40880 Ratingen,
Tel. +49 (0) 21 02 / 49 89-0, Fax. +49 (0) 21 02 / 49 89-20
Internet: www.buehler-technologies.com

RMA-Formular und Erklärung über Dekontaminierung

RMA-Form and explanation for decontamination



RMA-Nr./ RMA-No.

Die RMA-Nr. bekommen Sie von Ihrem Ansprechpartner im Vertrieb oder Service. Bei Rücksendung eines Altgeräts zur Entsorgung tragen Sie bitte in das Feld der RMA-Nr. "WEEE" ein./ You may obtain the RMA number from your sales or service representative. When returning an old appliance for disposal, please enter "WEEE" in the RMA number box.

Zu diesem Rücksendeschein gehört eine Dekontaminierungserklärung. Die gesetzlichen Vorschriften schreiben vor, dass Sie uns diese Dekontaminierungserklärung ausgefüllt und unterschrieben zurücksenden müssen. Bitte füllen Sie auch diese im Sinne der Gesundheit unserer Mitarbeiter vollständig aus./ This return form includes a decontamination statement. The law requires you to submit this completed and signed decontamination statement to us. Please complete the entire form, also in the interest of our employee health.

Firma/ Company

Firma/ Company

Straße/ Street

PLZ, Ort/ Zip, City

Land/ Country

Gerät/ Device

Anzahl/ Quantity

Auftragsnr./ Order No.

Ansprechpartner/ Person in charge

Name/ Name

Abt./ Dept.

Tel./ Phone

E-Mail

Serien-Nr./ Serial No.

Artikel-Nr./ Item No.

Grund der Rücksendung/ Reason for return

- Kalibrierung/ Calibration Modifikation/ Modification
 Reklamation/ Claim Reparatur/ Repair
 Elektroaltgerät/ Waste Electrical & Electronic Equipment (WEEE)
 andere/ other

bitte spezifizieren/ please specify

Ist das Gerät möglicherweise kontaminiert?/ Could the equipment be contaminated?

- Nein, da das Gerät nicht mit gesundheitsgefährdenden Stoffen betrieben wurde./ No, because the device was not operated with hazardous substances.
 Nein, da das Gerät ordnungsgemäß gereinigt und dekontaminiert wurde./ No, because the device has been properly cleaned and decontaminated.
 Ja, kontaminiert mit:/ Yes, contaminated with:



explosiv/
explosive



entzündlich/
flammable



brandfördernd/
oxidizing



komprimierte
Gase/
compressed
gases



ätzend/
caustic



giftig,
Lebensgefahr/
poisonous, risk
of death



gesundheitsge-
fährdend/
harmful to
health



gesund-
heitsschädlich/
health hazard



umweltge-
fährdend/
environmental
hazard

Bitte Sicherheitsdatenblatt beilegen!/ Please enclose safety data sheet!

Das Gerät wurde gespült mit:/ The equipment was purged with:

Diese Erklärung wurde korrekt und vollständig ausgefüllt und von einer dazu befugten Person unterschrieben. Der Versand der (dekontaminierten) Geräte und Komponenten erfolgt gemäß den gesetzlichen Bestimmungen.

This declaration has been filled out correctly and completely, and signed by an authorized person. The dispatch of the (decontaminated) devices and components takes place according to the legal regulations.

Falls die Ware nicht gereinigt, also kontaminiert bei uns eintrifft, muss die Firma Bühler sich vorbehalten, diese durch einen externen Dienstleister reinigen zu lassen und Ihnen dies in Rechnung zu stellen.

Should the goods not arrive clean, but contaminated, Bühler reserves the right, to commission an external service provider to clean the goods and invoice it to your account.

Firmenstempel/ Company Sign

Datum/ Date

rechtsverbindliche Unterschrift/ Legally binding signature



Vermeiden von Veränderung und Beschädigung der einzusendenden Baugruppe

Die Analyse defekter Baugruppen ist ein wesentlicher Bestandteil der Qualitätssicherung der Firma Bühler Technologies GmbH. Um eine aussagekräftige Analyse zu gewährleisten muss die Ware möglichst unverändert untersucht werden. Es dürfen keine Veränderungen oder weitere Beschädigungen auftreten, die Ursachen verdecken oder eine Analyse unmöglich machen.

Umgang mit elektrostatisch sensiblen Baugruppen

Bei elektronischen Baugruppen kann es sich um elektrostatisch sensible Baugruppen handeln. Es ist darauf zu achten, diese Baugruppen ESD-gerecht zu behandeln. Nach Möglichkeit sollten die Baugruppen an einem ESD-gerechten Arbeitsplatz getauscht werden. Ist dies nicht möglich sollten ESD-gerechte Maßnahmen beim Austausch getroffen werden. Der Transport darf nur in ESD-gerechten Behältnissen durchgeführt werden. Die Verpackung der Baugruppen muss ESD-konform sein. Verwenden Sie nach Möglichkeit die Verpackung des Ersatzteils oder wählen Sie selber eine ESD-gerechte Verpackung.

Einbau von Ersatzteilen

Beachten Sie beim Einbau des Ersatzteils die gleichen Vorgaben wie oben beschrieben. Achten Sie auf die ordnungsgemäße Montage des Bauteils und aller Komponenten. Versetzen Sie vor der Inbetriebnahme die Verkabelung wieder in den ursprünglichen Zustand. Fragen Sie im Zweifel beim Hersteller nach weiteren Informationen.

Einsenden von Elektroaltgeräten zur Entsorgung

Wollen Sie ein von Bühler Technologies GmbH stammendes Elektroprodukt zur fachgerechten Entsorgung einsenden, dann tragen Sie bitte in das Feld der RMA-Nr. „WEEE“ ein. Legen Sie dem Altgerät die vollständig ausgefüllte Dekontaminierungserklärung für den Transport von außen sichtbar bei. Weitere Informationen zur Entsorgung von Elektroaltgeräten finden Sie auf der Webseite unseres Unternehmens.

Avoiding alterations and damage to the components to be returned

Analysing defective assemblies is an essential part of quality assurance at Bühler Technologies GmbH. To ensure conclusive analysis the goods must be inspected unaltered, if possible. Modifications or other damages which may hide the cause or render it impossible to analyse are prohibited.

Handling electrostatically conductive components

Electronic assemblies may be sensitive to static electricity. Be sure to handle these assemblies in an ESD-safe manner. Where possible, the assemblies should be replaced in an ESD-safe location. If unable to do so, take ESD-safe precautions when replacing these. Must be transported in ESD-safe containers. The packaging of the assemblies must be ESD-safe. If possible, use the packaging of the spare part or use ESD-safe packaging.

Fitting of spare parts

Observe the above specifications when installing the spare part. Ensure the part and all components are properly installed. Return the cables to the original state before putting into service. When in doubt, contact the manufacturer for additional information.

Returning old electrical appliances for disposal

If you wish to return an electrical product from Bühler Technologies GmbH for proper disposal, please enter "WEEE" in the RMA number box. Please attach the fully completed decontamination declaration form for transport to the old appliance so that it is visible from the outside. You can find more information on the disposal of old electrical appliances on our company's website.

