



Portable Oxygen Analyser

BA 4000 Inj.

Installation and Operation Instructions

Original instructions





Bühler Technologies GmbH, Harkortstr. 29, D-40880 Ratingen
Tel. +49 (0) 21 02 / 49 89-0, Fax: +49 (0) 21 02 / 49 89-20
Internet: www.buehler-technologies.com
E-Mail: analyse@buehler-technologies.com

Read this instruction carefully prior to installation and/or use. Pay attention particularly to all advises and safety instructions to prevent injuries. Bühler Technologies can not be held responsible for misusing the product or unreliable function due to unauthorised modifications.

All rights reserved. Bühler Technologies GmbH 2023

Document information

Document No.....BE550004
Version..... 02/2021

Contents

1	Introduction	2
1.1	Intended Use	2
1.2	Design types	2
1.3	Ordering instructions	2
1.4	Functional principle	2
1.5	Scope of delivery	2
2	Safety instructions	3
2.1	Important notices	3
2.2	General hazard warnings	4
3	Transport and storage	5
4	Installation and connection	6
4.1	Installation site requirements	6
4.2	Electrical connections	6
4.3	Sample gas supply	6
4.4	Gas connections	7
5	Operation and Control	8
5.1	Calibration	8
5.1.1	Test gases for calibration	9
5.1.2	Calibration for BA 4000 Inj. GV	9
5.1.3	Calibration for BA 4000 Inj. KV	10
5.1.4	Carrier gas influence (cross-sensitivity)	10
5.2	Notes on operating the BA 4000 Inj. KV/D with pressure gauge (optional)	10
5.3	Performing the measurement	11
6	Service	12
6.1	Replacing the rechargeable battery	12
7	Service and repair	13
7.1	Troubleshooting	13
7.2	Spare parts and accessories	13
8	Disposal	15
9	Appendix	16
9.1	Technical Data	16
9.2	Puncture devices	17
9.3	Flow charts	17
10	Attached documents	18

1 Introduction

1.1 Intended Use

The portable BA 4000 Inj. Bühler O₂ analyser is a special unit for determining oxygen in low gas volumes.

This analyser is a modification of the BA 4000, primarily used in the food industry to analyse small residual amounts in modified atmosphere packaging, bottles or tins. The O₂ content in insulating glass panes can also be determined. There are 2 versions.

The device **must not be used**

- To analyse combustible, inflammable or explosive gas mixtures,
- In explosive areas and
- For applications where equipment failure or malfunction puts persons in immediate danger.

1.2 Design types

The **BA 4000 Inj. GV** is used for volumes > 35 ml. The duration of the internal sample gas pump can optionally be controlled using an adjustable timing relay.

The **BA 4000 Inj. KV** is used for gas volumes < 35 ml. This analyser is operated by a vacuum pump. There are different puncturing devices available, depending on the type of packaging.

An optional pressure gauge is available for use with vacuum packaging. This allows for comparing O₂ concentrations at different package pressures. It further allows for zero point calibration without zero gas.

1.3 Ordering instructions

Device model

Item no.	Description
55 11 399	BA 4000 Inj. GV
55 11 5991	BA 4000 Inj. KV

1.4 Functional principle

The measuring cell on the analyser uses the paramagnetic principle, utilising the paramagnetic properties of oxygen. In practice, the quality of gas conditioning and the mechanical strain (impact, shock) limit the life of the measuring cell.

The **BA 4000 Inj. GV** is designed as a portable unit and can be used for monitoring changing locations.

1.5 Scope of delivery

- Analyser
- Product documentation
- Connection/mounting accessories (optional)

2 Safety instructions

2.1 Important notices

Operation of the device is only valid if:

- the product is used under the conditions described in the installation- and operation instruction, the intended application according to the type plate and the intended use. In case of unauthorized modifications done by the user Bühler Technologies GmbH can not be held responsible for any damage,
- when complying with the specifications and markings on the nameplates.
- the performance limits given in the datasheets and in the installation- and operation instruction are obeyed,
- monitoring devices and safety devices are installed properly,
- service and repair is carried out by Bühler Technologies GmbH,
- only original spare parts are used.

This manual is part of the equipment. The manufacturer keeps the right to modify specifications without advanced notice. Keep this manual for later use.

Please particularly note the following analyser instructions:











- Always transport the equipment diligently and carefully. Strong impact and shock may damage the measuring cells in the analyser or shorten their life!
- Disconnect from the mains before opening the unit.
- **BA 4000 Inj. GV: This unit has a 12 V battery, which is always energised.**

Signal words for warnings

DANGER	Signal word for an imminent danger with high risk, resulting in severe injuries or death if not avoided.
WARNING	Signal word for a hazardous situation with medium risk, possibly resulting in severe injuries or death if not avoided.
CAUTION	Signal word for a hazardous situation with low risk, resulting in damaged to the device or the property or minor or medium injuries if not avoided.
NOTICE	Signal word for important information to the product.

Warning signs

In this manual, the following warning signs are used:

	Warning against hazardous situations		General notice
	Warning against electrical voltage		Disconnect from mains
	Warning against respiration of toxic gases		Wear respirator
	Warning against acid and corrosive substances		Wear eye/face protection
	Warning against potentially explosive atmospheres		Wear protection gloves
	Warning against hot surface		

2.2 General hazard warnings

The equipment must be installed by a professional familiar with the safety requirements and risks.

Be sure to observe the safety regulations and generally applicable rules of technology relevant for the installation site. Prevent malfunctions and avoid personal injuries and property damage.

The operator of the system must ensure:

- Safety notices and operating instructions are available and observed,
- The respective national accident prevention regulations are observed,
- The permissible data and operational conditions are maintained,
- Safety guards are used and mandatory maintenance is performed,
- Legal regulations are observed during disposal,
- compliance with national installation regulations.

Maintenance, Repair

Please note during maintenance and repairs:

- Repairs to the unit must be performed by Bühler authorised personnel.
- Only perform conversion-, maintenance or installation work described in these operating and installation instructions.
- Always use genuine spare parts.
- Do not install damaged or defective spare part. If necessary, visually inspect prior to installation to determine any obvious damage to the spare parts.

Always observe the applicable safety and operating regulations in the respective country of use when performing any type of maintenance.

DANGER

Electrical voltage

Electrocution hazard.



- a) Disconnect the device from power supply.
- b) Make sure that the equipment cannot be reconnected to mains unintentionally.
- c) The device must be opened by trained staff only.
- d) Regard correct mains voltage.



DANGER

Toxic, acidic gasses

Sample gas / calibrating gas can be harmful.



- a) If necessary, ensure a safe gas discharge.
- b) Switch off the gas supply before performing maintenance and protect from opening inadvertently.
- c) Protect yourself from toxic / corrosive gasses when performing maintenance. Wear suitable protective equipment.



DANGER

Potentially explosive atmosphere

Explosion hazard if used in hazardous areas.



The device is not suitable for operation in hazardous areas with potentially explosive atmospheres.

Do not expose the device to combustible or explosive gas mixtures.

3 Transport and storage

Transport

The unit is sensitive to shock and vibration. Therefore, where possible, transport in the original packaging or large, sturdy packaging at a minimum consisting of 3 layer carton, plastic or aluminium sheet. Line the inside of the packaging with padding at least 10 cm thick on all sides.

The unit should be marked fragile for shipping.

Removal from service and storage

Purge the unit with dry nitrogen or dry air before removing from service for extended periods. Then close the gas inputs and outputs to prevent dirt, dust and moisture from entering the unit.

Store the unit in a dry, ventilated, dust-free room. Cover the unit with suitable packaging to protect it from liquids and dirt.

Storage temperature: -20 °C ... +50 °C

4 Installation and connection

4.1 Installation site requirements

DANGER



Potentially explosive atmosphere

Explosion hazard if used in hazardous areas.
The device is not suitable for operation in hazardous areas with potentially explosive atmospheres.
Do not expose the device to combustible or explosive gas mixtures.

This unit is intended for use in protected rooms. If necessary, protect from the weather when used outdoors.

The analyser should only be set up on a solid, stable surface. In the event of strong vibration or shock nearby, provide a highly cushioning intermediate layer.

4.2 Electrical connections

WARNING



Hazardous electrical voltage

The device must be installed by trained staff only.

CAUTION



Wrong mains voltage

Wrong mains voltage may damage the device.
Regard the correct mains voltage as given on the type plate.

The **BA 4000 Inj. GV** can be operated without mains access after adequately charging the built-in storage battery. Only use the included plug-in charger. The charging time varies based on the level of the rechargeable battery. When fully drained it should be at least 15 h. **Please keep the charger connected if the unit will not be used for extended periods (battery trickle charging). Never exhaust the rechargeable battery.**

Only operate the **BA 4000Inj KV** with the plug-in charger.

Verify the plug-in charger matches the power supply available on site before use.

4.3 Sample gas supply

The sample gas supply should use the same sample gas path as during measurement. Most importantly, the pressure, temperature and flow rate should be the same.

NOTICE



Please note, any change in the temperature and air pressure compared over the last calibration will change the measurements.

4.4 Gas connections

The sample gas inlet is located in the front panel and uses a M6x0.75 hose connection.

The sample gas outlet is located at the back of the unit in form of a hose coupling. With built-in sample gas pump the primary pressure must not exceed max. 5 mbar.

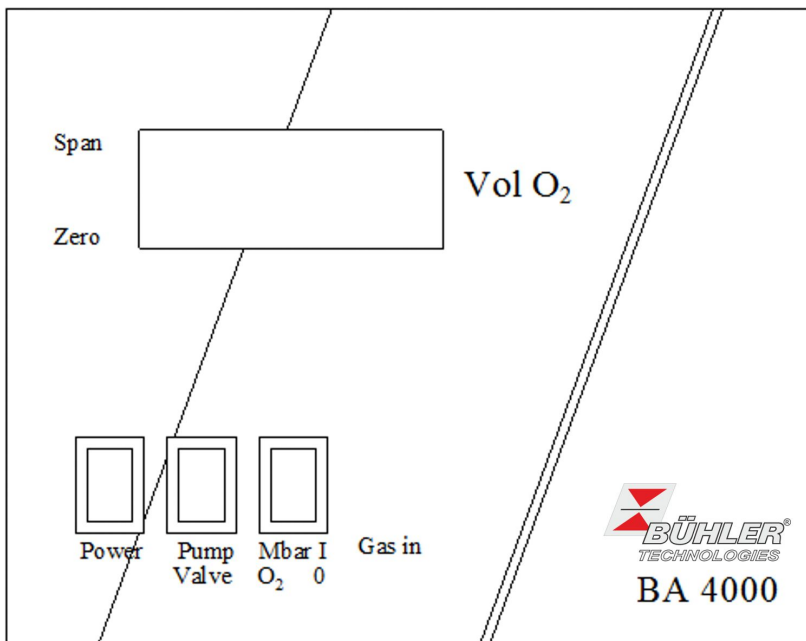

Fig. 1: Front view

5 Operation and Control

NOTICE



The device must not be operated beyond its specifications.

The measuring signal of the unit can be picked up via the D-Sub plug at the back of the unit. The following image shows the assignment. In addition, the mA output for the pressure indicator can be picked up (4-20 mA = 0-1100 mbar). The max. load for the optional output is 300 Ohm.

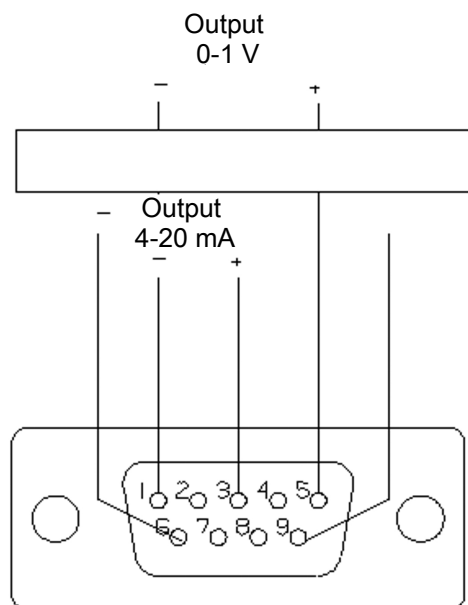

Fig. 2: D-Sub plug configuration

The unit is calibrated at the factory. However, the calibration can change due to the ageing process and environmental conditions. These changes in the measuring performance is called drift. The calibration should therefore be checked before every series of measurements to eliminate measuring errors.

The unit should be calibrated in the following cases:

- with every initial operation, after the warm-up period
- after great changes in the barometric pressure (changes in weather)
- when the room temperature changes more than 5 °C
- routinely during operation (approx. 1 x per month)

5.1 Calibration

Since the measuring system is linear, two calibration points will suffice for the check:

-Zero point

The zero point corresponds with the measurement if there is no oxygen in the measuring cell and there is neutral gas such as nitrogen in the unit.

-Measuring range (sensitivity)

The sensitivity for the measuring range is set with span gas or ambient air (~20.9 % O₂).

NOTICE



Calibration can only be performed with stagnant gas.

5.1.1 Test gases for calibration

-Zero gas

Zero gas is used to calibrate the zero point. It must not contain oxygen and should not be susceptible to magnetism. Depending on the application, nitrogen N₂ or carbon dioxide CO₂ can be used as zero gas. The selector switch at the back of the unit must be set accordingly.

-Span gas

Span gas is used to calibrate the sensitivity (in the measuring range). It is a mixture of oxygen and the respective zero gas or ambient air. The oxygen content of the span gas should be as close to the O₂ ratio of the sample gas. However, it should not be less than 15 Vol.%.

NOTICE



The span gas should preferably be added under the same conditions as the sample gas. When using sample gas conditioning, the span gas should therefore be added upstream from this system.

Span gas supply:

For units with built-in sample gas pump:

- Add the span gas via T-fitting with the sample gas pump on.
- Set the output pressure on the span gas cylinder so an excess of span gas is dispersed at the T-fitting.

For units without built-in sample gas pump:

- The span gas should be added to the unit with the same pressure and the same flow rate as the sample gas.

5.1.2 Calibration for BA 4000 Inj. GV

The unit should be on for approx. 30 min. before calibrating it so all components are at operating temperature. The puncture device should be removed from the gas inlet during calibration.

Adjusting the zero point

- Switch on the pump using the pump/valve switch.
- Connect a hose to the gas inlet. Connect the test gas cylinder and set the pressure regulator on the cylinder to max. 0.1 bar overpressure.
Use the same anaerobic gas (N₂ or CO₂) as the zero gas used to gas the packaging to be tested. Set the toggle switch at the back of the unit to the corresponding setting.
- Slowly open the valve on the pressure regulator. If the reading on the analyser's gauge fluctuates, reduce the pressure with the pressure regulator.
- If the reading is steady, switch off the pump, shut off the zero gas and disconnect the hose (calibration with stagnant gas).
- Use the zero potentiometer to set to 0.0 %.

Adjusting the range (sensitivity)

- Connect a hose to the gas inlet. Switch on the pump using the pump/valve switch, add span gas or ambient air and wait for the reading to stabilise.
- Switch off the pump/valve switch and disconnect the hose.
- If necessary, set the "Span" potentiometer via the front panel on the unit so the value matches the span gas (e.g. 20.9 Vol.% for air).

In the event of significant deviations from setpoint during calibration, it's advisable to repeat calibration to verify.

5.1.3 Calibration for BA 4000 Inj. KV

The unit should be on for approx. 30 min. before calibrating it so all components are at operating temperature. The puncture device should be removed from the gas inlet during calibration.

Setting the zero point with zero gas

Disconnect the connection hose to the vacuum pump. Switch on the pump/valve switch (1), which will open the solenoid valve.

- Connect a hose to the gas inlet. Connect the test gas cylinder and set the pressure regulator on the cylinder to max. 0.1 bar overpressure.
Use the same anaerobic gas (N₂ or CO₂) as the zero gas used to gas the packaging to be tested. Set the toggle switch at the back of the unit to the corresponding setting.
- Slowly open the valve on the pressure regulator. If the reading on the analyser's gauge fluctuates, reduce the pressure with the pressure regulator.
- If the reading is steady, set the pump/valve switch to 0, which will close the solenoid valve. Disconnect the hose (calibration with stagnant gas).
- Use the zero potentiometer to set to 0.0 %.

Adjusting the zero point via pressure gauge (optional)

With an optional pressure gauge (BA 4000 Inj. KV/D), the zero point calibration requires no zero gas. The toggle switch at the back of the unit must be in the position corresponding with the filling gas for the packaging.

- Attach the connection hose to the vacuum pump. Switch off the pump/valve switch, which will close the solenoid valve.
- Switch on the mbar/O₂ switch. The display will show the pressure.
- Switch on the vacuum pump.
- Once the required vacuum has been created, switch off the mbar / O₂ switch. The O₂ concentration will appear.
- Use the zero potentiometer to set to 0.0 %.

Adjusting the range (sensitivity)

- Attach the connection hose to the vacuum pump. Switch on the pump/valve switch (1), which will open the solenoid valve.
- Switch on the vacuum pump, air or the span gas will be drawn in.
- Once the reading is steady, switch off the pump/valve switch, which will close the solenoid valve (calibration with stagnant gas).
- If necessary, set the "Span" potentiometer via the front panel on the unit so the value matches the span gas (e.g. 20.9 Vol.% for air).

5.1.4 Carrier gas influence (cross-sensitivity)

The selectivity of the unit's measuring method is based on the extreme magnetic susceptibility (measured variable for magnetisation) of oxygen. The magnetic susceptibility of other gases is typically so low that its influence on the measurement can be vastly disregarded.

Significant measuring errors only occur when e.g. using nitrogen as the zero gas for calibration, but using CO₂ as the sample gas (filling gas for the packaging). The unit will then show a value, even if the sample gas contains no oxygen, i.e. it is cross-sensitive to the other gas component. In this case, recalibrate with the toggle switch at the back of the unit in the correct position. If the measurement is still incorrect, please contact Service for assistance.

5.2 Notes on operating the BA 4000 Inj. KV/D with pressure gauge (optional)

Use the mbar/O₂ switch to toggle between displaying the pressure and concentration. The pressure is displayed in mbar, the concentration in Vol.%. So in addition to the concentration, the internal pressure for the packaging can also be displayed.

5.3 Performing the measurement

- Attach the needle to the puncture device.
- Apply a self-adhesive piece of rubber to the packaging.
- **BA 4000 Inj. KV:** Only insert the needle far enough into the piece of rubber, at an angle, to cover the side bore. Switch on the pump/valve switch, which will open the solenoid valve. Switch on the vacuum pump and evacuate the analyser.
- Once a vacuum has been created, switch off the pump/valve switch, which will close the solenoid valve.
- Insert the needle all the way into the packaging. The residual gas in the packaging will flow into the analyser. With an optional "pressure gauge", the display can be toggled between O₂ concentration and pressure (mbar/O₂ switch).
- **BA 4000 Inj. GV:** Insert the needle through the piece of rubber and into the packaging. Switch on the pump/valve switch, filling gas will be drawn from the packaging.
- When the reading is steady, switch off the pump, the O₂ concentration will appear.

6 Service

During maintenance, remember:

- The equipment must be maintained by a professional familiar with the safety requirements and risks.
- Only perform maintenance work described in these operating and installation instructions.
- When performing maintenance of any type, observe the respective safety and operation regulations.

DANGER

Electric voltage



Risk of electric shock

- Disconnect the unit from the mains when performing any maintenance.
- Secure the equipment from accidental restarting.
- The unit may only be maintained and opened by instructed, competent personnel.



DANGER

Toxic, acidic gasses



Sample gas / calibrating gas can be harmful.

- If necessary, ensure a safe gas discharge.
- Switch off the gas supply before performing maintenance and protect from opening inadvertently.
- Protect yourself from toxic / corrosive gasses when performing maintenance. Wear suitable protective equipment.



The measuring cell and, if applicable, the built-in sample gas pump, are maintenance free except for occasional calibration. The built-in protective filter in the puncture device must be checked regularly and replaced if dirty.

6.1 Replacing the rechargeable battery

BA 4000 Inj. GV only:

Depending on the operating and ambient conditions, the rechargeable battery will occasionally need to be replaced (typical life approx. 4-5 years).

We recommend having the battery replaced by the factory to also have the internal gas paths and the measuring cell.

7 Service and repair

This chapter contains information on troubleshooting and correction should an error occur during operation.

Repairs to the unit must be performed by Bühler authorised personnel.

Please contact our Service Department with any questions:

Tel.: +49-(0)2102-498955 or your agent

If the equipment is not functioning properly after correcting any malfunctions and switching on the power, it must be inspected by the manufacturer. Please send the equipment inside suitable packaging to:

Bühler Technologies GmbH

- Reparatur/Service -

Harkortstraße 29

40880 Ratingen

Germany

Please also attach the completed and signed RMA decontamination statement to the packaging. We will otherwise be unable to process your repair order.

You will find the form in the appendix of these instructions, or simply request it by e-mail:

service@buehler-technologies.com.

7.1 Troubleshooting

Problem / Malfunction	Possible cause	Action
No display	- "Power" switch off	- Toggle switch up
	- Rechargeable battery in the BA 4000 Inj. GV drained	- Plug in the wall power supply and connect to the BA 4000; the display must light up immediately.
	- Fuse at the back of the BA 4000 defective	- Replace fuse
The value displayed deviates significantly from the calibrated value or the sample gas measurement to be expected	- The ambient or unit temperature when switching the unit on was far below the permissible value of 5 °C	- Switch off the "Power" switch and switch on again after 10 sec - If necessary, recalibrate
	- Measuring system vibrates	- Switch off the "Power" switch and switch on again after 10 sec - If necessary, recalibrate

7.2 Spare parts and accessories

Item no.	Description	Recommended for 2 years of service
55 07 09 91	Measuring cell	-
55 05 99 910	Rechargeable battery (BA 4000Inj GV only)	1
55 11 09 91	Internal pump (BA 4000 GV only)	1
55 05 99 95	Valve (BA 4000 KV only)	1
91 10 000 002	Fuse	2
91 10 000 049	Fuse holder	-
55 05 99 94	Gas inlet screw-in connection	-
91 36 000 020	Toggle switch	-
55 10 44 014	Supply board	-
55 10 23 005	Display	-
55 10 44 009	Amplifier board	-

Accessories

Item no.	Description
65 70 520	Vacuum pump 230 V
65 70 521	Vacuum pump 115 V
55 11 0994	Pressure gauge
65 71 999	EV-1
65 70 9021	EV-3
65 70 901	Needles for EV-3
65 70 9012	Needles for EV-1
65 70 970	Septum for EV-3 (1 m)
65 70 971	Septum for EV-3 (10 m)
65 70 9471	Septum for EV-1 (33 m)
65 70 9033	Pre-filter for EV-3
65 70 975	Water Stop fine mesh filter
55 11 0992	Wall power supply for GV 100-240 V AC, 12 V DC
91 12 000014	Wall power supply for KV 100-240 V AC, 15 V DC

8 Disposal

The applicable national laws must be observed when disposing of the products. Disposal must not result in a danger to health and environment.

The crossed out wheellie bin symbol on Bühler Technologies GmbH electrical and electronic products indicates special disposal notices within the European Union (EU).



The crossed out wheellie bin symbol indicates the electric and electronic products bearing the symbol must be disposed of separate from household waste. They must be properly disposed of as waste electrical and electronic equipment.

Bühler Technologies GmbH will gladly dispose of your device bearing this mark. Please send your device to the address below for this purpose.



We are obligated by law to protect our employees from hazards posed by contaminated devices. Therefore please understand that we can only dispose of your waste equipment if the device is free from any aggressive, corrosive or other operating fluids dangerous to health or environment. **Please complete the "RMA Form and Decontamination Statement", available on our website, for every waste electrical and electronic equipment. The form must be applied to the packaging so it is visible from the outside.**

Please return waste electrical and electronic equipment to the following address:

Bühler Technologies GmbH
WEEE
Harkortstr. 29
40880 Ratingen
Germany

Please also observe data protection regulations and remember you are personally responsible for the returned waste equipment not bearing any personal data. Therefore please be sure to delete your personal data before returning your waste equipment.

9 Appendix

9.1 Technical Data

Technical Data	
Measuring component:	Oxygen
Measuring range (specify when ordering):	0 ... 25 Vol. %
Measuring principle:	paramagnetic cell measuring principle
Measuring Data	
Accuracy:	0.1 % O ₂ absolute
Reproducibility:	± 0.05 % O ₂
Response time:	T ₉₀ <10 s
Zero drift:	± 0.1 Vol.% O ₂ per week
Sensitivity drift:	± 1% of measuring span per week
Gas inlet conditions	
Gas temperature:	+5 °C to 40 °C
Sample gas conditioning	
Dew point:	at least 5 °C below ambient temperature
Dust particles:	Equipment filter with replaceable 8µ filter element
Calibration	
Zero point:	with nitrogen (technically pure), optionally with vacuum
Endpoint:	with ambient air or test gas, depending on the measuring range
Climatic conditions	
Ambient temperature:	+10 °C to 45 °C
Transport and storage temperature:	-25 °C to 65 °C
Relative humidity:	<75 % annual average
Measurement output	
Current signal:	4...20 mA (max. 400 Ω)
Voltage signal:	0...1 V (min. 1 k Ω) optional
Displays	
Measurement display:	LCD 3½ digits
Power supply	
Wall power supply:	100-240 V, 50/60 Hz
Construction	
Housing:	Aluminium housing with handle
Housing protection class:	IP20 (standard)
Dimensions (h x w x d):	145 x 182 x 240 mm (standard housing)
Weight	approx. 4.5 kg

9.2 Puncture devices

EV-1

Puncture device for single-hand operation. Suitable for sampling gas from soft packaging of modified atmosphere packed products.

EV-3

Puncture device with fixed needle. Suitable for sampling gas from soft packaging of modified atmosphere packed products. The additional fine mesh filter also makes it suitable for sampling packages with powdered products, e.g. coffee.

Water Stop fine mesh filter

For protecting the measuring cell when analysing moist gasses (bottles, tinned foods). Filters particles, the special coating retains water liquids and aerosols.

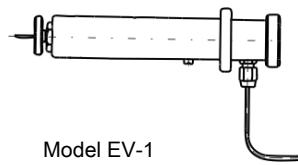

Model EV-1
for soft packaging

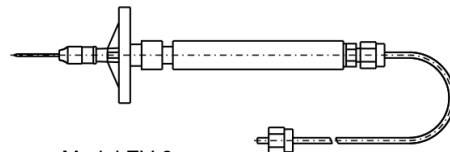

Model EV-3
for soft packaging

9.3 Flow charts

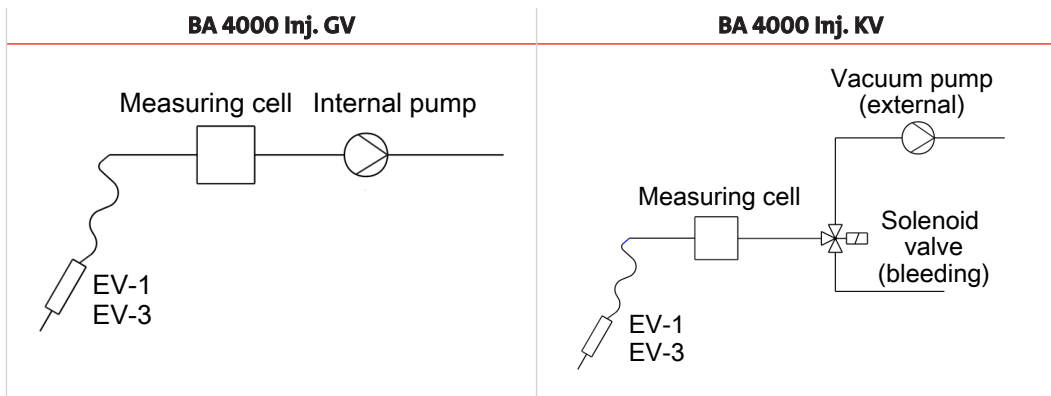

10 Attached documents

- Declaration of Conformity KX550004
- RMA - Decontamination Statement

EU-Konformitätserklärung
EU-declaration of conformity



Hiermit erklärt Bühler Technologies GmbH,
dass die nachfolgenden Produkte den
wesentlichen Anforderungen der Richtlinie

*Herewith declares Bühler Technologies GmbH
that the following products correspond to the
essential requirements of Directive*

2014/35/EU
(Niederspannungsrichtlinie / low voltage directive)

in ihrer aktuellen Fassung entsprechen.

in its actual version.

Folgende Richtlinie wurde berücksichtigt:

The following directive was regarded:

2014/30/EU (EMV/EMC)

Produkt / products: Sauerstoffanalysator / Oxygen analyser
Typ / type: BA 4000, BA 4000 Inj.

*Das Betriebsmittel dient zur Messung von Sauerstoff in Gasen.
The equipment is for measuring the oxygen content of gases.*

*Das oben beschriebene Produkt der Erklärung erfüllt die einschlägigen
Harmonisierungsrechtsvorschriften der Union:
The object of the declaration described above is in conformity with the relevant Union harmonisation
legislation:*

EN 61000-6-3:2007/A1:2011
EN 61000-6-2:2005/AC:2005

EN 61010-1:2010/A1:2019/AC:2019-04
EN 60204-1:2018

*Die alleinige Verantwortung für die Ausstellung dieser Konformitätserklärung trägt der Hersteller.
This declaration of conformity is issued under the sole responsibility of the manufacturer.*

*Dokumentationsverantwortlicher für diese Konformitätserklärung ist Herr Stefan Eschweiler mit
Anschrift am Firmensitz.
The person authorized to compile the technical file is Mr. Stefan Eschweiler located at the company's
address.*

Ratingen, den 17.02.2023

Stefan Eschweiler
Geschäftsführer – *Managing Director*

Frank Pospiech
Geschäftsführer – *Managing Director*

UK Declaration of Conformity



The manufacturer Bühler Technologies GmbH declares, under the sole responsibility, that the product complies with the requirements of the following UK legislation:

Electrical Equipment Safety Regulations 2016

The following legislation were regarded:

Electromagnetic Compatibility Regulations 2016

Product: Oxygen analyser
Types: BA 4000
BA 4000 Inj.

The equipment is for measuring the oxygen content of gases.

The object of the declaration described above is in conformity with the relevant designated standards:

EN 61000-6-3:2007/A1:2011
EN 61000-6-2:2005/AC:2005

EN 61010-1:2010/A1:2019/AC:2019-04
EN 60204-1:2018

Ratingen in Germany, 17.02.2023

A handwritten signature in blue ink, appearing to read 'Stefan Eschweiler', written over a horizontal line.

Stefan Eschweiler
Managing Director

A handwritten signature in blue ink, appearing to read 'Frank Pospiech', written over a horizontal line.

Frank Pospiech
Managing Director

RMA-Formular und Erklärung über Dekontaminierung

RMA-Form and explanation for decontamination



RMA-Nr./ RMA-No.

Die RMA-Nr. bekommen Sie von Ihrem Ansprechpartner im Vertrieb oder Service. Bei Rücksendung eines Altgeräts zur Entsorgung tragen Sie bitte in das Feld der RMA-Nr. "WEEE" ein./ You may obtain the RMA number from your sales or service representative. When returning an old appliance for disposal, please enter "WEEE" in the RMA number box.

Zu diesem Rücksendeschein gehört eine Dekontaminierungserklärung. Die gesetzlichen Vorschriften schreiben vor, dass Sie uns diese Dekontaminierungserklärung ausgefüllt und unterschrieben zurücksenden müssen. Bitte füllen Sie auch diese im Sinne der Gesundheit unserer Mitarbeiter vollständig aus./ This return form includes a decontamination statement. The law requires you to submit this completed and signed decontamination statement to us. Please complete the entire form, also in the interest of our employee health.

Firma/ Company

Firma/ Company

Straße/ Street

PLZ, Ort/ Zip, City

Land/ Country

Gerät/ Device

Anzahl/ Quantity

Auftragsnr./ Order No.

Ansprechpartner/ Person in charge

Name/ Name

Abt./ Dept.

Tel./ Phone

E-Mail

Serien-Nr./ Serial No.

Artikel-Nr./ Item No.

Grund der Rücksendung/ Reason for return

- Kalibrierung/ Calibration Modifikation/ Modification
 Reklamation/ Claim Reparatur/ Repair
 Elektroaltgerät/ Waste Electrical & Electronic Equipment (WEEE)
 andere/ other

bitte spezifizieren/ please specify

Ist das Gerät möglicherweise kontaminiert?/ Could the equipment be contaminated?

- Nein, da das Gerät nicht mit gesundheitsgefährdenden Stoffen betrieben wurde./ No, because the device was not operated with hazardous substances.
 Nein, da das Gerät ordnungsgemäß gereinigt und dekontaminiert wurde./ No, because the device has been properly cleaned and decontaminated.
 Ja, kontaminiert mit:/ Yes, contaminated with:



explosiv/
explosive



entzündlich/
flammable



brandfördernd/
oxidizing



komprimierte
Gase/
compressed
gases



ätzend/
caustic



giftig,
Lebensgefahr/
poisonous, risk
of death



gesundheitsge-
fährdend/
harmful to
health



gesund-
heitsschädlich/
health hazard



umweltge-
fährdend/
environmental
hazard

Bitte Sicherheitsdatenblatt beilegen!/ Please enclose safety data sheet!

Das Gerät wurde gespült mit:/ The equipment was purged with:

Diese Erklärung wurde korrekt und vollständig ausgefüllt und von einer dazu befugten Person unterschrieben. Der Versand der (dekontaminierten) Geräte und Komponenten erfolgt gemäß den gesetzlichen Bestimmungen.

This declaration has been filled out correctly and completely, and signed by an authorized person. The dispatch of the (decontaminated) devices and components takes place according to the legal regulations.

Falls die Ware nicht gereinigt, also kontaminiert bei uns eintrifft, muss die Firma Bühler sich vorbehalten, diese durch einen externen Dienstleister reinigen zu lassen und Ihnen dies in Rechnung zu stellen.

Should the goods not arrive clean, but contaminated, Bühler reserves the right, to commission an external service provider to clean the goods and invoice it to your account.

Firmenstempel/ Company Sign

Datum/ Date

rechtsverbindliche Unterschrift/ Legally binding signature



Vermeiden von Veränderung und Beschädigung der einzusendenden Baugruppe

Die Analyse defekter Baugruppen ist ein wesentlicher Bestandteil der Qualitätssicherung der Firma Bühler Technologies GmbH. Um eine aussagekräftige Analyse zu gewährleisten muss die Ware möglichst unverändert untersucht werden. Es dürfen keine Veränderungen oder weitere Beschädigungen auftreten, die Ursachen verdecken oder eine Analyse unmöglich machen.

Umgang mit elektrostatisch sensiblen Baugruppen

Bei elektronischen Baugruppen kann es sich um elektrostatisch sensible Baugruppen handeln. Es ist darauf zu achten, diese Baugruppen ESD-gerecht zu behandeln. Nach Möglichkeit sollten die Baugruppen an einem ESD-gerechten Arbeitsplatz getauscht werden. Ist dies nicht möglich sollten ESD-gerechte Maßnahmen beim Austausch getroffen werden. Der Transport darf nur in ESD-gerechten Behältnissen durchgeführt werden. Die Verpackung der Baugruppen muss ESD-konform sein. Verwenden Sie nach Möglichkeit die Verpackung des Ersatzteils oder wählen Sie selber eine ESD-gerechte Verpackung.

Einbau von Ersatzteilen

Beachten Sie beim Einbau des Ersatzteils die gleichen Vorgaben wie oben beschrieben. Achten Sie auf die ordnungsgemäße Montage des Bauteils und aller Komponenten. Versetzen Sie vor der Inbetriebnahme die Verkabelung wieder in den ursprünglichen Zustand. Fragen Sie im Zweifel beim Hersteller nach weiteren Informationen.

Einsenden von Elektroaltgeräten zur Entsorgung

Wollen Sie ein von Bühler Technologies GmbH stammendes Elektroprodukt zur fachgerechten Entsorgung einsenden, dann tragen Sie bitte in das Feld der RMA-Nr. „WEEE“ ein. Legen Sie dem Altgerät die vollständig ausgefüllte Dekontaminierungserklärung für den Transport von außen sichtbar bei. Weitere Informationen zur Entsorgung von Elektroaltgeräten finden Sie auf der Webseite unseres Unternehmens.

Avoiding alterations and damage to the components to be returned

Analysing defective assemblies is an essential part of quality assurance at Bühler Technologies GmbH. To ensure conclusive analysis the goods must be inspected unaltered, if possible. Modifications or other damages which may hide the cause or render it impossible to analyse are prohibited.

Handling electrostatically conductive components

Electronic assemblies may be sensitive to static electricity. Be sure to handle these assemblies in an ESD-safe manner. Where possible, the assemblies should be replaced in an ESD-safe location. If unable to do so, take ESD-safe precautions when replacing these. Must be transported in ESD-safe containers. The packaging of the assemblies must be ESD-safe. If possible, use the packaging of the spare part or use ESD-safe packaging.

Fitting of spare parts

Observe the above specifications when installing the spare part. Ensure the part and all components are properly installed. Return the cables to the original state before putting into service. When in doubt, contact the manufacturer for additional information.

Returning old electrical appliances for disposal

If you wish to return an electrical product from Bühler Technologies GmbH for proper disposal, please enter "WEEE" in the RMA number box. Please attach the fully completed decontamination declaration form for transport to the old appliance so that it is visible from the outside. You can find more information on the disposal of old electrical appliances on our company's website.

